

J1250

Continuous Tubular Centrifuge



hanil



Product name

Continuous Centrifuge J1250

Manufacturing company

Hanil Science Industry Co., Ltd.

16, Arayuk-ro, Gochon-eup, Gimpo-si, Gyeonggi-do

www.ihanil.com

packaging unit

1 set including main body, control unit and accessories

The contents of the user manual are subject to change without notice.

© 2022 Hanil Scientific Inc. All rights reserved.

UM-J1250(E)(Rev.1), 2022.09.29

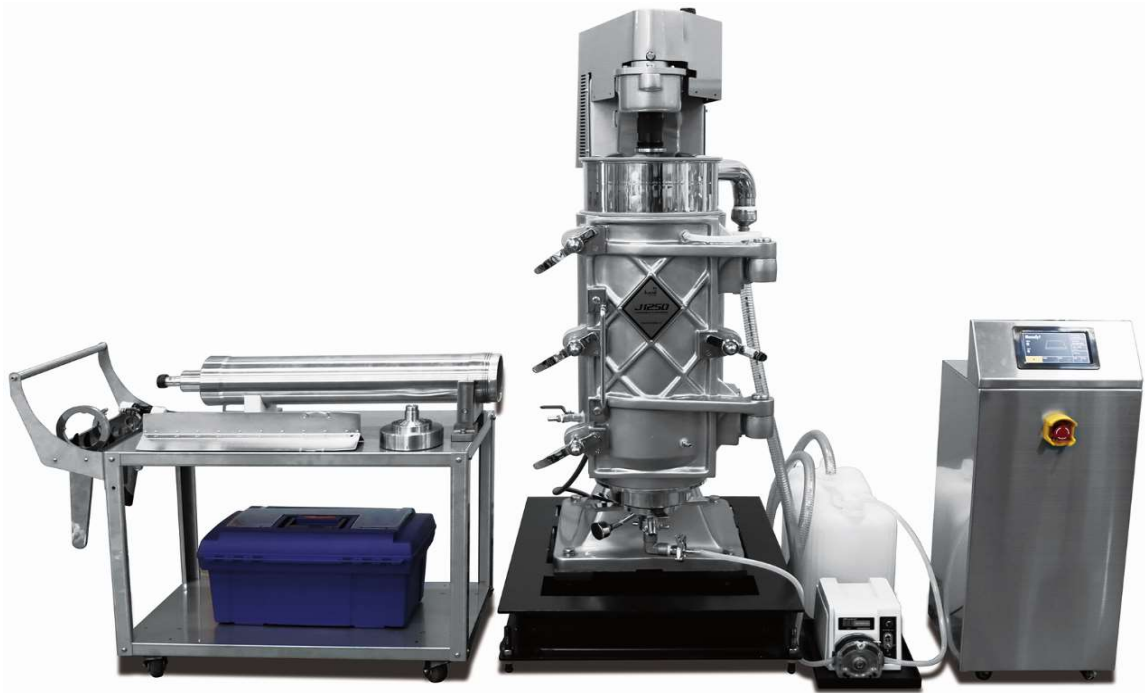

CONTENTS

1. Precautions for safety	----- 6
1.1 General safety instructions	----- 6
1.2 Precautions for use	----- 7
1.3 Precautions when installing the product	----- 8
2. Product overview and composition	----- 9
2.1 Technical Specifications Main Unit	----- 10
2.2 Technical Specifications Control Unit	----- 11
2.3 Product composition	----- 12
2.3.1 Main unit configuration	----- 12
2.3.2 Accessories	----- 12
2.4 Configuration for each part	----- 13
2.4.1 Main unit configuration and dimension	----- 13
2.4.2 Tool kit and use	----- 15
2.4.3 Sample feeding pump	----- 18
2.4.4 Control unit configuration and dimension	----- 20
3. Product installation	----- 21
3.1 Instrument installation and balancing	----- 21
3.2 Power Connection	----- 23
4. How to use the control unit and precautions	----- 24
4.1 Control panel	----- 24
4.2 Overall operation flow chart	----- 26
4.3 Loading screen	----- 27
4.4 Setting the speed	----- 27
4.5 Time setting	----- 28
4.6 Acceleration/deceleration step setting	----- 29
4.7 History screen	----- 30
4.8 Saving History	----- 31
4.9 Saving, Recalling and Deleting Programs	----- 32
4.10 Start/Stop	----- 34
4.11 Emergency stop	----- 35
4.12 Pump Operation	----- 36
4.13 Operation completion status display	----- 37
4.14 Setting screen	----- 38
4.15 Error status display during operation	----- 43

CONTENTS

5. Preparing and How to Drive	----- 44
5.1 Bowl assembly	----- 44
5.1.1 Insert Teflon sheet	----- 45
5.1.2 Inserting the triangular rotor blade	----- 46
5.2 Drag body assembly mounting	----- 48
5.3 Bowl installation	----- 48
5.4 Bowl and Motor Spindle fastening	----- 50
5.5 Things to check before driving	----- 52
5.6 Driving	----- 53
6. Disassembly and maintenance	----- 54
6.1 Disassembly	----- 54
6.2 Cleaning	----- 54
6.3 Daily Inspection	----- 55
6.4 Maintenance	----- 55
6.5 Bad Code Description	----- 57
7. Ordering Information	----- 58

1. Precautions for safety

Because this equipment rotates at high speed, the risk of accidents is very high if mishandled. In order to use the centrifuge effectively and safely, please read the following precautions. Since the instruction manual is part of the product, always place it around the product.

1.1 General safety instructions

- ① Before supplying power, remove all packaging materials used to prevent damage during transportation.
 - Install in a dry environment, avoiding high temperature and high humidity.
 - Use only cables and devices supplied by the manufacturer. The manufacturer is not responsible for any problems caused by the user's arbitrary change and use.
 - The manufacturer is not responsible for any problems caused by improper operation by the user outside the range allowed by the device.
 - Before use, be sure to check each part to make sure that there is no abnormality in the centrifuge. In particular, do not use the centrifuge that has been operated by another person without checking the status.

- ⑥ Do not place near objects such as towels or cloths that may get caught in rotating parts (Pulley, Spindle, etc.) while driving. It is very dangerous to touch rotating parts, especially with cotton gloves.
 - Do not open the door of the outer bowl frame until the rotation is completely stopped.
 - Perform regular inspections on equipment, wiring, and piping.
 - If you find a stripped or broken cable, you must replace it immediately.
 - Use a suitable electric extension device or power outlet, and do not overload it.
 - Do not touch the device, socket outlet or switch with wet hands.
 - Do not change the electrical parts of the device or parts.

1.2 Precautions for use

Since this equipment is used in combination with a high-speed rotating continuous centrifuge and a control box, it is necessary to familiarize yourself with the precautions for use of each component.

Please check once more before use.

- Check if any of the necessary parts and devices are missing. (Refer to p12~13, p15~17)
- Check the power supply status and connection wiring conditions between the main body and the Control Box.
(see p23)
- Since it rotates at high speed, the rotating parts must be well balanced.
- Check if the Serial No. of the body, cap, and triangular rotor blades composing the bowl match before use. (see p8)
- For the best operation, use the bowl set that matches the serial number of the bowl attached to the front of the body. (see p8)
- The product installation site must be leveled and firmly fixed on a flat place.
- Check that there is no problem with the wiring connected to the device, and connect the power cord to the device that requires power.
- Do not place any obstructive objects within 60cm of the device.
- Do not touch or impact the main body while it is operating.
- As this is a device that uses electricity, be careful not to get an electric shock when handling it.
- Do not use flammable, hazardous, or radioactive substances that can generate volatile or explosive vapors.
- In case of an emergency, operate the emergency switch and open the door after confirming that the product is stopped. (see p35)
- When not operating the device, turn off the power.

1.3 Precautions when installing the product

1.3.1 Installation

This equipment is installed on a flat concrete floor and is used by balancing it with 6 balancing feet on the corners of the iron H-beam base at the bottom of the main body. For more reliable use, it can be operated by driving anchor bolts into the floor. When installing this equipment, it is recommended to proceed after sufficiently consulting with the technical person in charge of the manufacturer.

In the installation space, a work space of 60cm or more must be secured on the left, right, and rear of the equipment, and sufficient space must be secured in the front.

>> Precautions

Bowl configuration and configuration with the main body

- Serial No. is engraved on each of the 3 parts of the bowl as shown in the picture on the right.
- Bowls must be configured in one set with the same Serial No. for the best operation, so never mix them.
- The sticker shown on the right is attached to the outer surface of the main body, and the Serial No. Use bowl sets from xxxxxx.

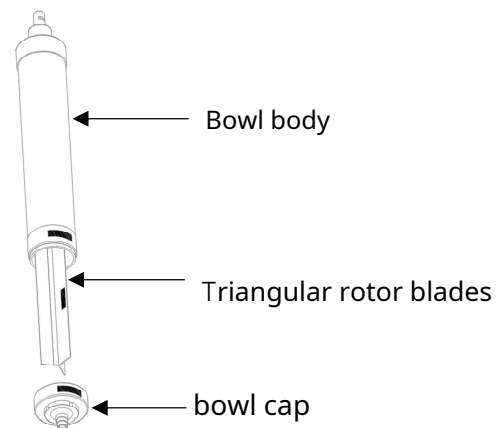

/ WARNING /

For optimal use, this product
Serial No. xxxxxx Bowl Set with
use it.

inquiry : techsupport@ihnil.com

1.3.2 Electrical installation work

This equipment requires a 3-phase 4-wire 380V power supply, so electrical work is required before installation.

- The control unit should be located where it is easy to operate.
- For electrical wiring and outlet specifications, be sure to inquire with the manufacturer before installing the power supply.

1.3.3 Flexible tube

- Use flexible tube for piping for feed sample.
- If the supply pipe and sample collection container are located in the front, it may cause inconvenience to work and movement, so be sure to place them on the left or right side.
- Select and use a pump suitable for the supply pressure. (Refer to p18~19)

2. Product overview and composition

This equipment is for separating the supernatant, which is the liquid part of the sample, and the sludge, which is the solid part, so that it is suitable for the process needs such as sample precipitation, filtration and washing. designed.

Due to the long tube-shaped rotor, the distance through which the mixed solution injected from the lower part of the rotor passes until it is centrifuged and discharged is long and receives the effect of strong centrifugal force for a relatively long time, so the centrifugation of the mixed solution is very good This can reduce process time and increase productivity compared to general centrifugation methods.

- Tubular type industrial centrifuge for continuous sample separation
- Two phase separation of liquid and solid
- High recovery of sludge (cake type)
- Water jacketed cooling system (optional)
- Premium quality stainless steel bowl
- Intuitive 7" touch-screen control
- Accurate control of speed through inverter
- Speed control from 1,000 to 15,000 RPM
- Distinctive emergency stop switch
- During operation, the door open sensor is detected and the motor is automatically stopped with an error phrase.
- The three-color blinking light can recognize normal operation status or emergency abnormal situation; green for normal, yellow for standby status, and red for errors and emergency.

2.1 Technical Specifications - Main Unit

Functions	Specification
main unit	
Motor	
Power	380V 3.7kW (3-phase)
Tubular Bowl	
Net Capacity (L) / Weight (kg)	9/27
Dimension (inner/outer)	157(Φ) x 142(Φ) x 960(L) mm
Material	Stainless Steel 316L
Sample Collection Sheet	Teflon with a dimension of 733x395x0.4 mm
Sample Feeding pump	Peristaltic Tubing Pump (WT600-2J)
Frame and Door, Material	Powder-painted Steel (optional) Stainless steel 304 (optional) Water-jacketed
Frame Base	Powder-painted Steel H-beam with 4 wheels and 6 balancing foot
Trolley for Bowl and Tools	Stainless steel trolley with tools in a box
Dimensions (With Base)	
Dimensions (W x D x H, mm) with H-beam base without pump or trolley	860(W) x 1085(D) x 1900(H) : Door closed 860(W) x 1430(D) x 1900(H) : Door open
Net Weight with bowl & H-beam base without pump or trolley	564 kg

2.2 Technical Specifications - Control Unit

Functions	Specification
control unit	
display screen	7" wide touch (Capacitive type)
speed control	1,000 to 15,000 RPM
Max. RCF	15,801 xg (Radius: 62.814 mm)
ACC/DEC ramps	3/4
program memory	99
Time control	< 100 hours
data transport	Yes (USB port)
History tracking	Yes
Inverter control	3P4W 380V, 7.5KW
Pump control	Selectable, auto or manual
Safeties	
Actual speed sensing	Yes
Door close/open sensing	Yes
Emergency Stop switch	Yes
foot switch	Optional
Level sensor 1, 2	Optional
Dimensions (W x D x H mm)	405x 460 x 1310 (incl. warning light)
Weight	
without cables	47 kg

2.3 Product composition

2.3.1 Main unit configuration

It is a tubular type continuous centrifuge and consists of a driving motor, a frame, a door, an H-beam base, and a bowl, a high-speed rotating chain. is supplied with

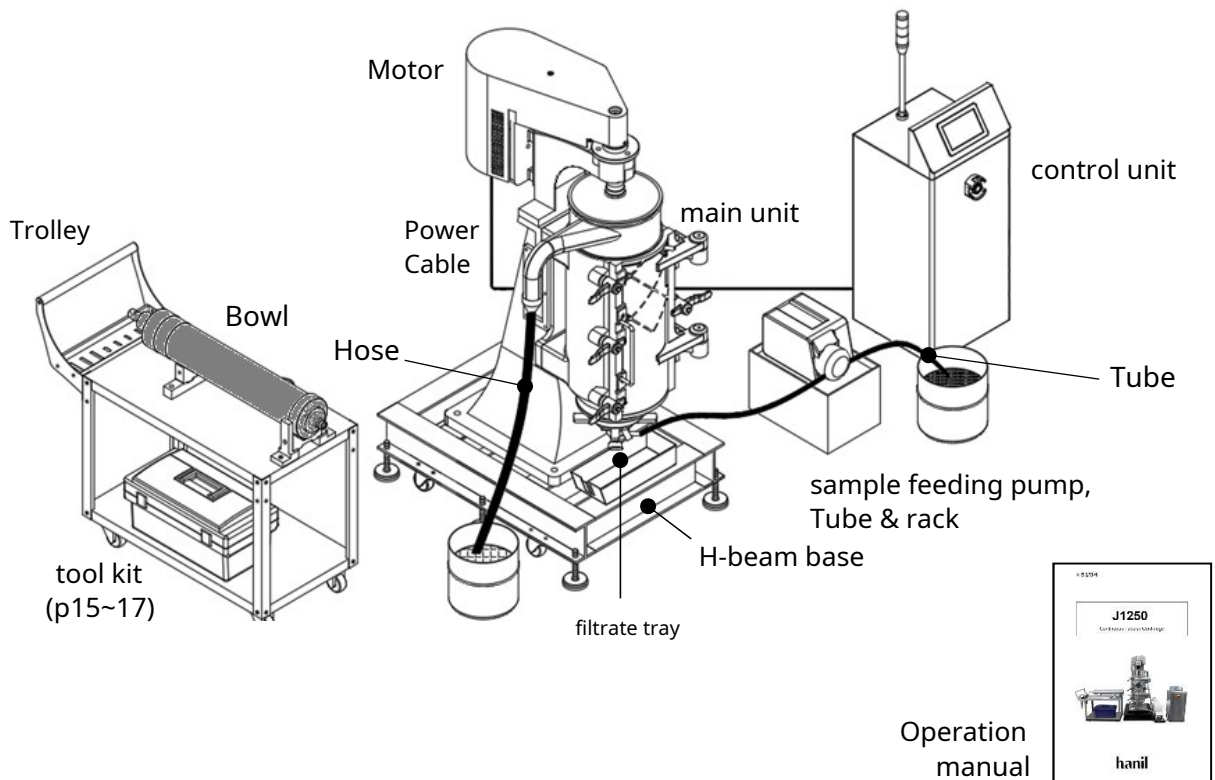

2.3.2 Accessories



Drag bushings, 2ea



Inlet Nozzles(3,4,5Ø), 3ea



Bowl cap sealing gasket, 2ea



rubber coupling, 2ea



Bowl cap nut 2ea



Teflon Sheet, 3 sheets
735x395x0.35 (W x L x T, mm)



Outlet Hose(1m)

2.4 Configuration for each part

2.4.1 Main unit configuration and dimensions

[Main part name]

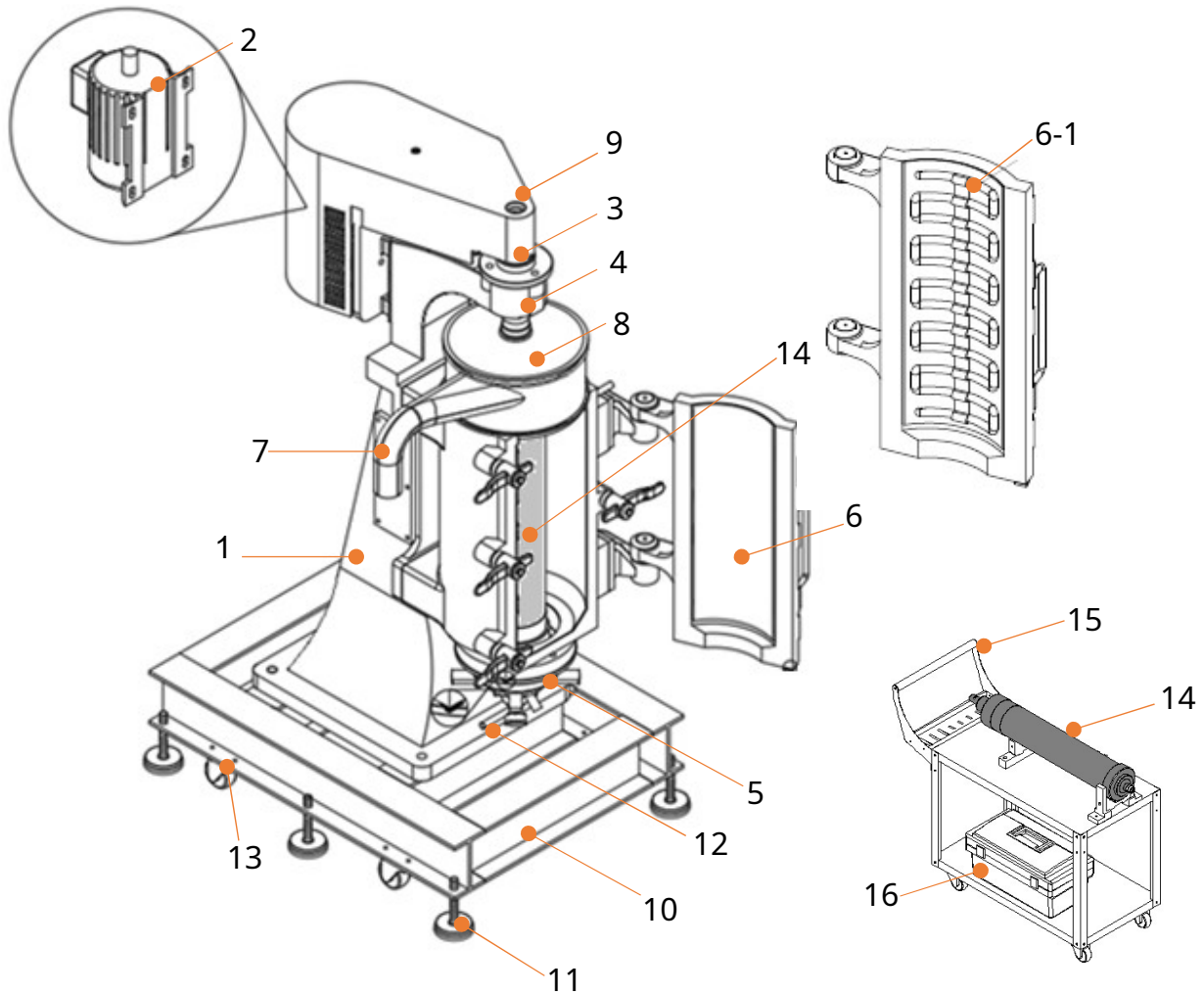



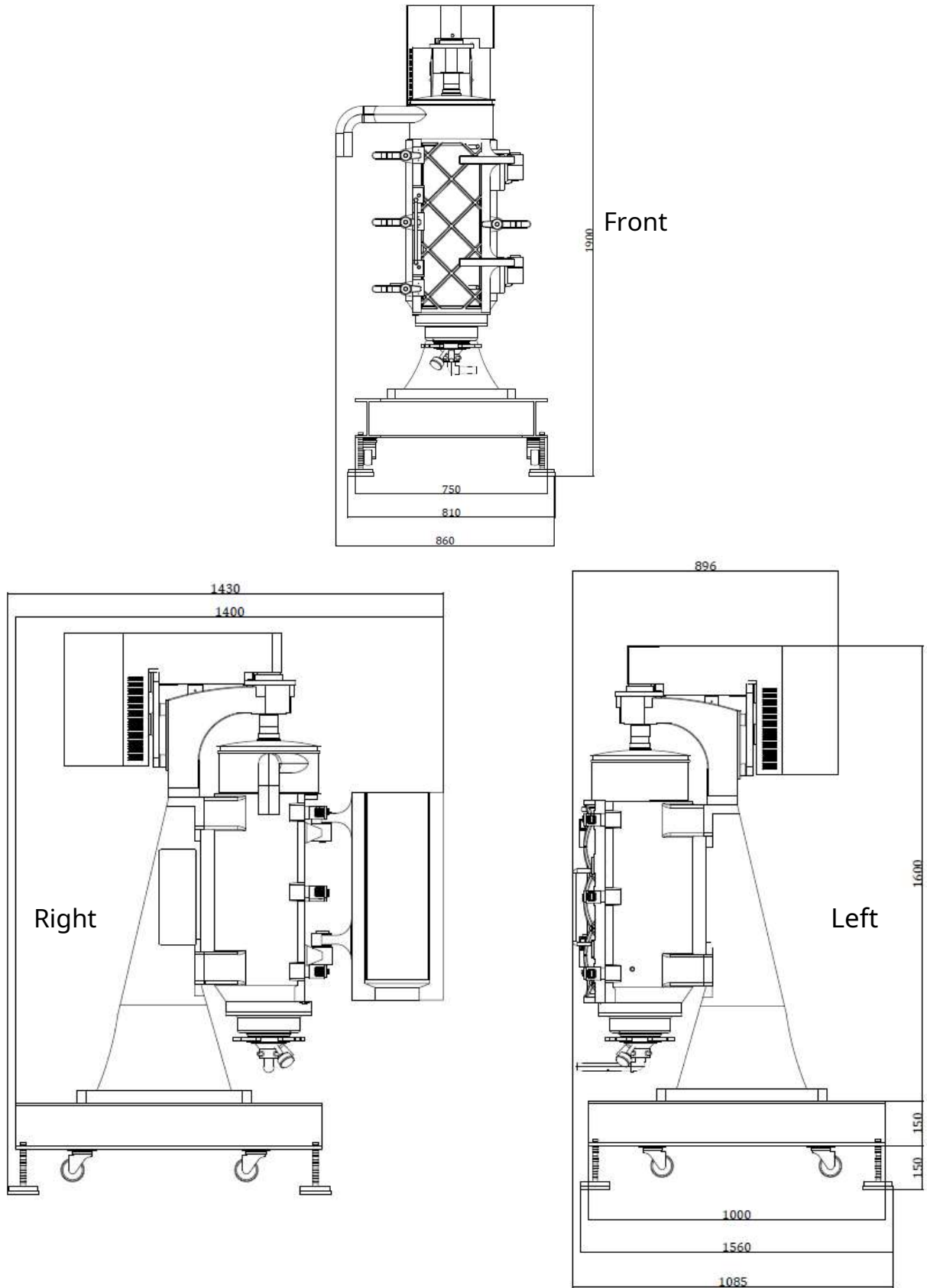

- | | | |
|--------------------------------------|------------------------|-----------------------------------|
| 1. Frame | 2. Motor | 3. Drive motor cover |
| 4. Pulley Flange | 5 . Drag Body Assembly | 6. Door |
| 6-1. water jacket door
(optional) | 7. Supernatant Outlet | 8. Supernatant Outlet Lid |
| 9. Balancing window | 10. Base, steel | 11. Balancing foot with nut 6 set |
| 12. Sample in gate | 13. Wheel | 14. Bowl |
| 15. Trolley | 16. Tool kit | |

[Main unit dimensions, mm]





2.4.2 Tool kit and use



[Bowl assembly & Disassembly tools]

No.	Photo	Name	Purpose
1		Bowl wrench	bowl cap open and close
2		2 Coupling wrenches	Bowl spindle assembly and disassembly
3		2 Pulley wrenches	61mm: for disassembling and assembling the pulley sleeve 54mm: for disassembling and assembling the bearing pulley
4		Bowl boss sleeve wrench	Bow cap nut disassembly and assembly
5		hook spanner	For triangular wing separation







[Drag Assembly & Disassembly Tools]

No.	Photo	Name	Purpose
1		Drag wrench	Drag shell disassembly and assembly
2		Pliers	For disassembling and assembling the parallel cap For disassembly and assembly of sample receiving hose nipple
3		Drag bushing tool	Drag bushing disassembly and assembly

[General Tools] - 1

No.	Photo	Name	Purpose
1		Monkey wrench	Drain pipe, grease, elbow, motor fixing bolt, cover fixing bolts, other assembly and disassembly
2		Urethane hammer	For bowl, drag assembly, and drag hand nut separation and fastening Opening and closing the door

[General Tools] - 2

No.	Photo	Name	Purpose
3		L-wrench	1.5~10,0mm 9 types Used to open and close the bowl cap
4		Balancing tool set	Tools for body balancing
5		Grease	Lubrication between bowl cap nut and drag bushing
6		2 Specials	For grease replenishment, Teflon sheet, and sludge separation
7		Bowl cleaner	For separating bowl and Teflon sheet For sludge separation
8		Bowl cleaning tools 3 types	Bowl cleaning tool
9		Tool box	Tool storage

2.4.3 Sample feeding pump

: WT600-2J Basic peristaltic tubing pump



Speed	60~600 rpm, CW/CCW
speed resolution	1 rpm
speed accuracy	<±1%
output torque	≥1.50N · M
control mode	Control panel, external signal control and communication control available
Display	3-digit LED displays current speed
external control	Start/stop, cw/ccw control speed control; 4 to 20 mA, 0.5 to 5 V, 1 to 10 V, 1 to 10 KHz
power supply	AC 176-264V 50/60Hz
Power consumption	≤200W
Operating condition	Temperature; 0~40°C relative humidity; <80%
Dimensions	285 L x 207 W x 180 H /mm
Weight	5.2 kg
IP rating	IP31

[Pump head and Tube selection guide]

pump head	Tubing	Flow rates (mL/min)
YZ1515	# 13, 14, 19, 16 25, 17, 18	4 to 2,200
YZ2515	#15, 24	100 to 1,600
YZII15	# 13, 14, 19, 16, 25, 17, 18	4 to 2,200
YZII25	#15, 24, 35, 36	100 to 3,000
DG15-24	#16, 25, 17	500 to 1,800
KZ25	#15, 24, 35, 36	200 to 6,000



When ordering a pump, please order the pump head & tubing according to the conditions.

inquiry : techsupport@ihanol.com

2.4.4 Control unit composition and Dimensions

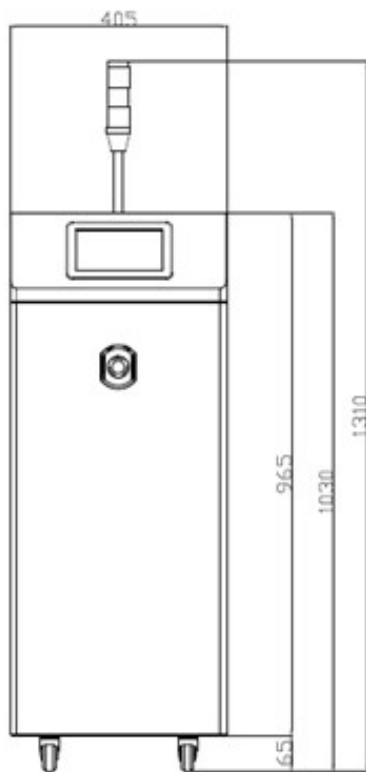
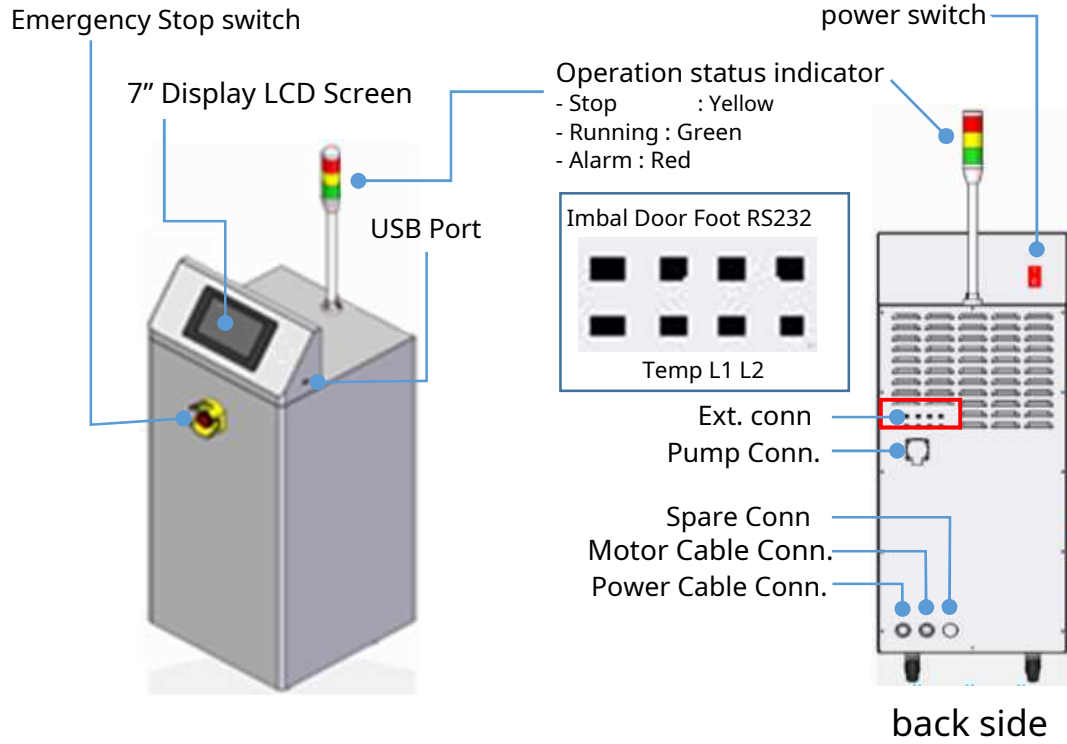

front side

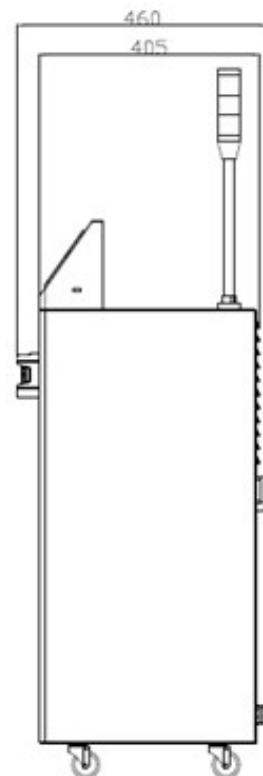

right side

3. Product installation

3.1 Instrument installation and balancing

① Open the balancing window on the top of the machine and pass the thread of the balancing kit (p17) through the center hole of the female clutch.

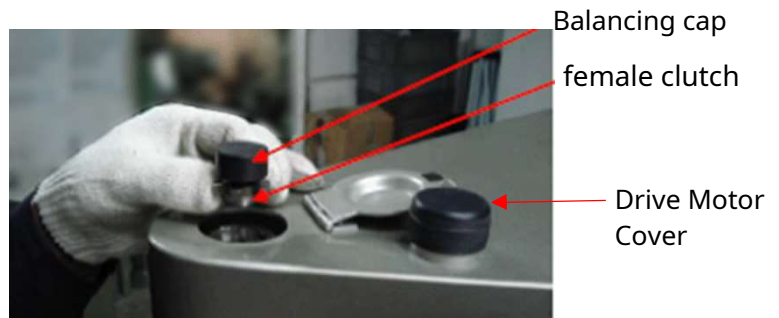

② Pass the upper part of the thread through the balancing cap, and tie the lower end to the weight nut.



③ Assemble the weight nut and weight.



Weight nut

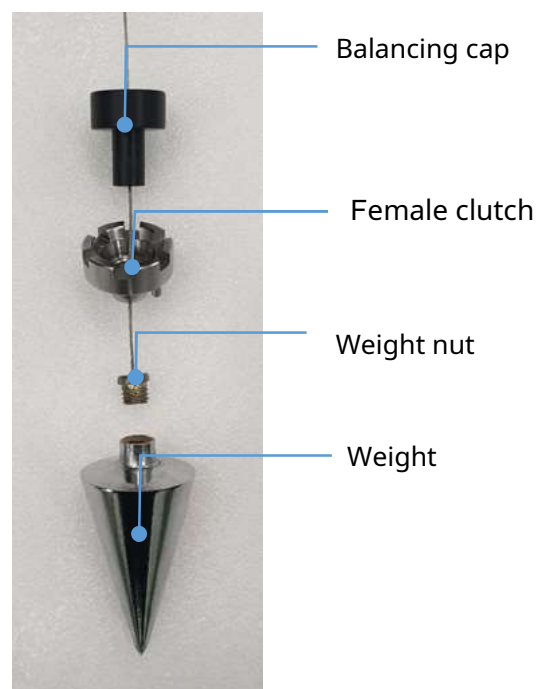

④ Bring the weight to the center of the nozzle hole of the drag body at the bottom of the device.

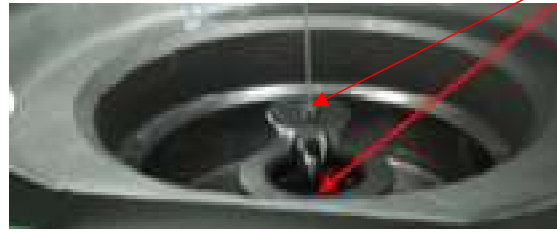

Weight
Nozzle hole

⑤ Wind the upper balancing cap thread around the Drive Motor Cover Bolt and fix it.



Drive Motor Cover Bolt

⑥ Adjust the height of the balancing foot so that the vertex of the weight is located at the center of the nozzle hole.

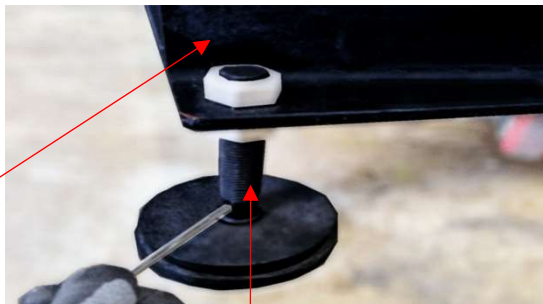

Base

Balancing foot



Nozzle hole

Drag body Assembly

⑦ After completing the adjustment of the balancing feet, fasten 2 nuts to the lower part of the H-beam both top and bottom.

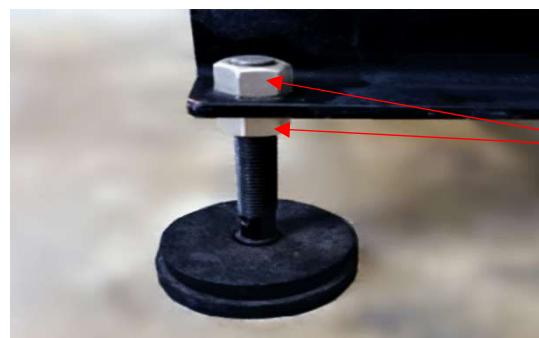

Nut

3.2 Power Connection

- Check the power configuration of the installation site.
- Three-phase, four-wire electrical work is required, and an external terminal box is installed near the product.
- Before connecting the power, check the wiring and connection status once more.
- Connect the power cable between the external terminal box and the control unit.
- Organize the product and surrounding facilities.
- After checking the input power and connection status, turn on the earth leakage breaker of the external terminal box.
- Turn on the power switch located on the back of the LCD of the control unit.

4. How to use the control unit and precautions

4.1 Control Panel

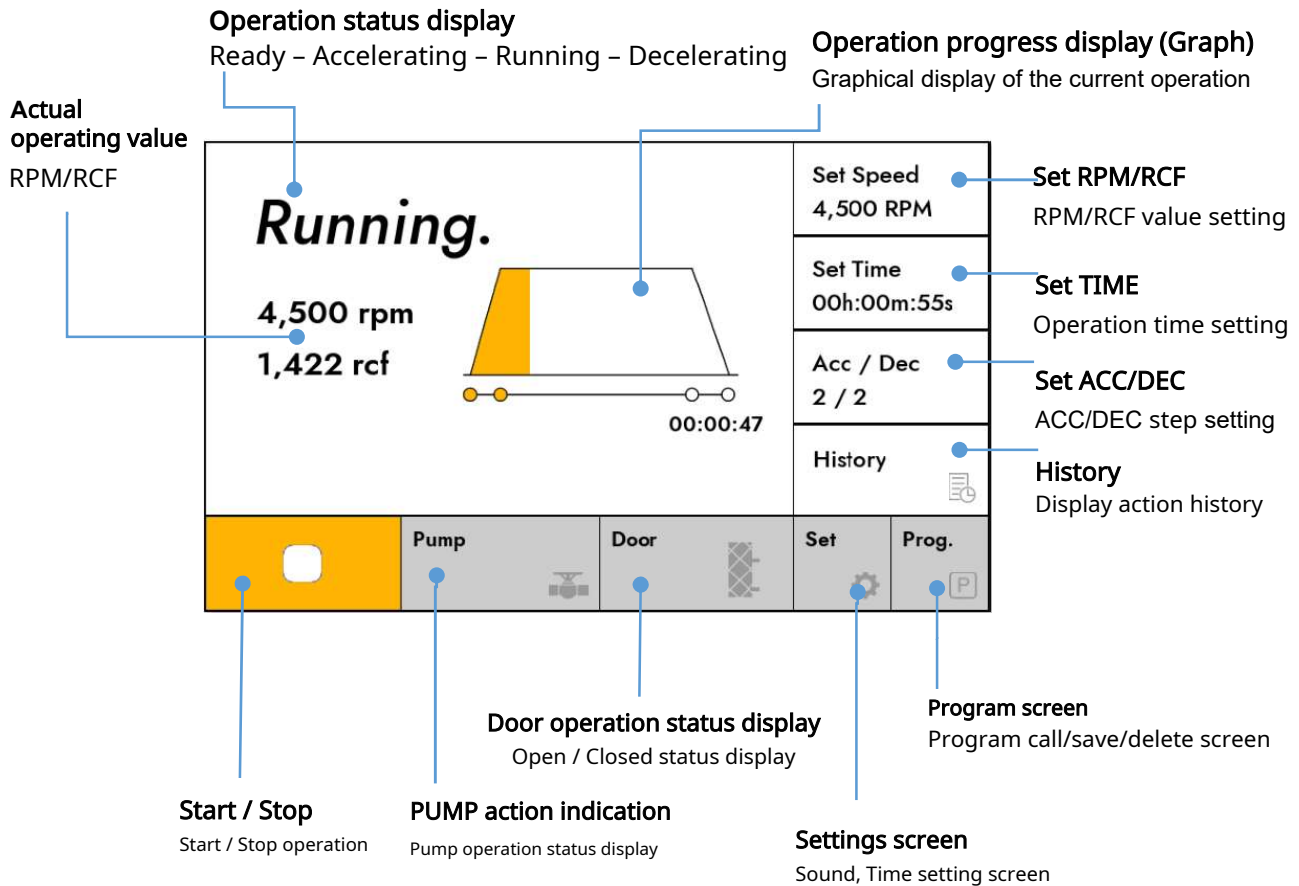

[UI Component Guide]

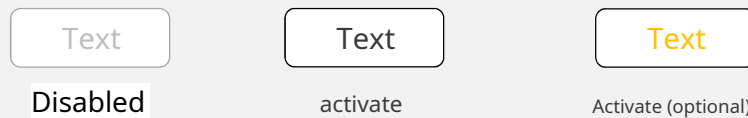

- For buttons that select functions and directions, only text is specified to increase intuition. Or, it is presented as icon + text to give directions. (Example: + More / <- Previous)
- Disabled Buttons cannot be touched.

- **RPM/RCF**

The rotation speed is expressed in RPM/RCF, and the maximum RPM is 15,000 and the maximum RCF is 15,801 xg. Also, the RPM/RCF value of the bowl is automatically calculated and displayed as a set value (set speed).

- **TIME**

The time can be set in hours, minutes and seconds, and can be set up to a maximum of 99 hours 59 minutes 59 seconds.

- **ACC/DEC**

The steps for setting the acceleration/deceleration time of the rotor can be set by dividing it into 3 acceleration steps from 1 to 3 and 4 deceleration steps from 0 to 3.

The higher the number, the faster the step.

- **Start / Stop**

It is used to start and stop motion.

- **Pump**

The pump operation status is displayed, and the icon is activated during operation.

The basic operation is that when the set RPM is reached, the pump automatically turns on and runs, and stops when it stops. In case of manual control during operation, ON/OFF control can be performed by touching the Pump Icon

(Optional) When adding a level sensor

- When Level Sensor 1 is detected, a warning message is displayed, and when Level 2 Sensor is detected, the pump is automatically turned off.

- **Door**

Displays Door Open/Closed status. In the Door Open state, even if Start is executed, it does not operate, and when Door Open is detected during operation, it is automatically stopped with an error.

- **SET**

You can check the setting value.

- **Program**

You can set program setting, loading, and deletion. Up to 99 programs can be saved.

4.2 Overall operation flow chart

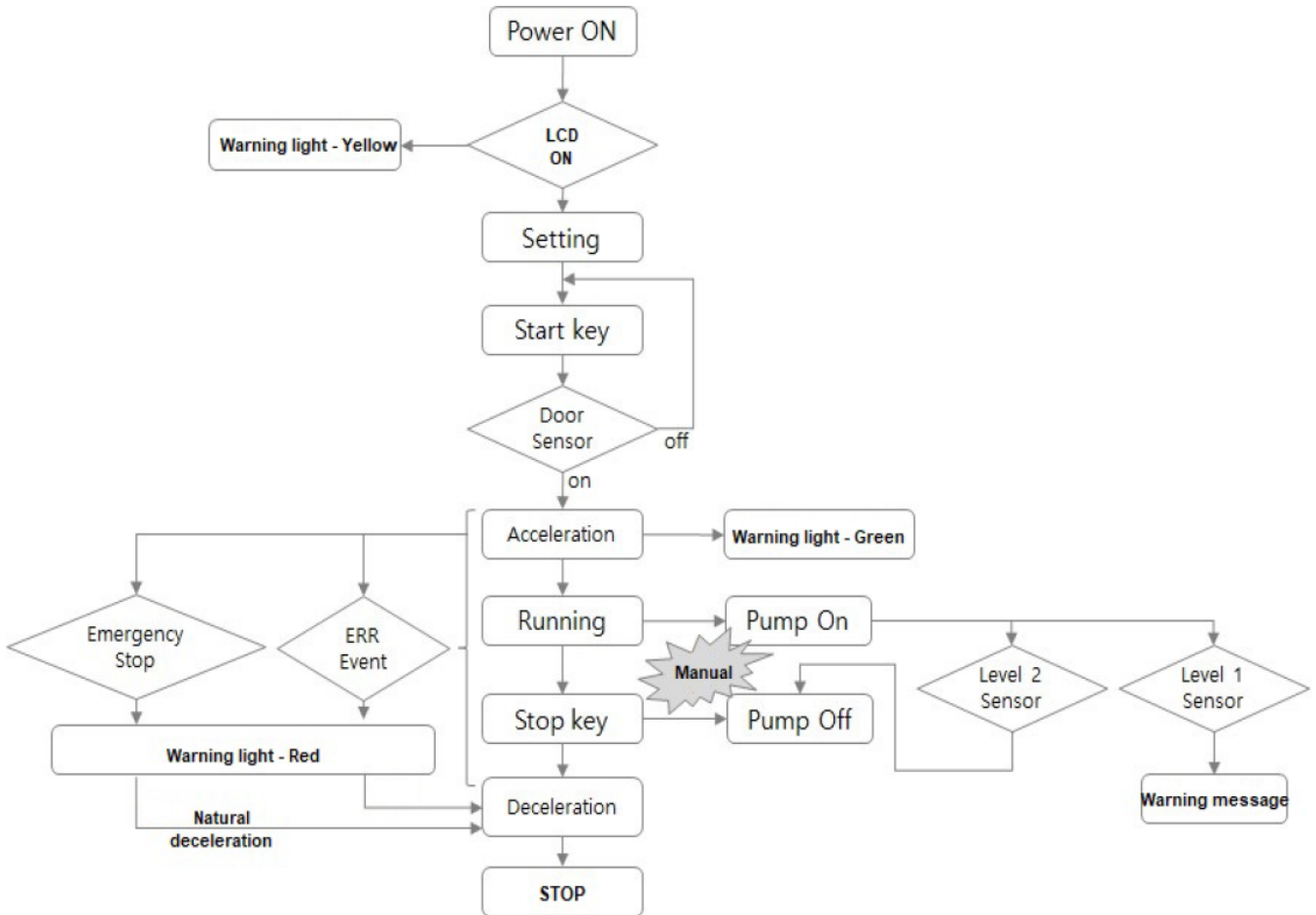

4.3 Loading screen

When all installation is complete, turn on the power switch behind the display, and it starts with the Hanil Scientific logo on the LCD screen.

When the Main screen appears, proceed according to the items for each setting condition.

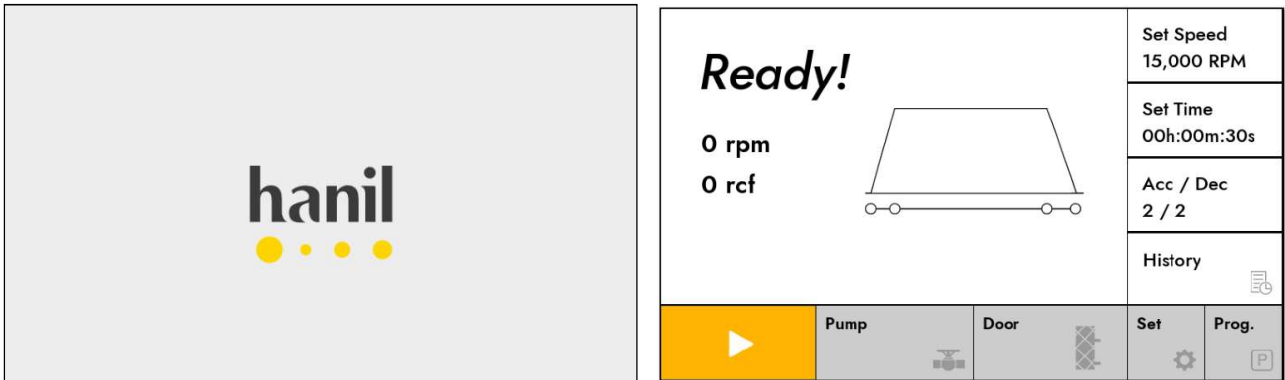

4.4 Setting the speed

The rotation speed is displayed in RPM/RCF, and the maximum RPM is 15,000 and the maximum RCF is 15,801 xg. RCF values for RPM are automatically calculated in conjunction with each other.

1) Press 'Set Speed' at the top right of the screen. The setting screen appears on the left side of the screen.

By touching the previously set RPM value, new value input can be done.

2) RPM / RCF conversion is automatically converted by pressing RPM/RCF on the numeric keys.

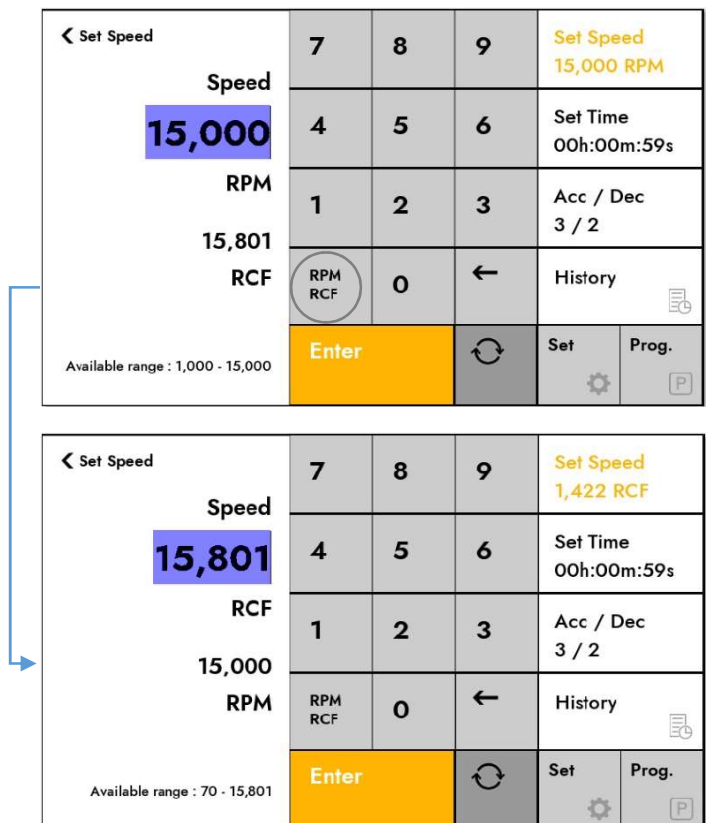

4.5 Time setting

The time can be set up to a maximum of 99 hours 59 minutes 59 seconds.

- Press 'Set Time' at the top right of the screen. The setting screen appears on the left side of the screen.

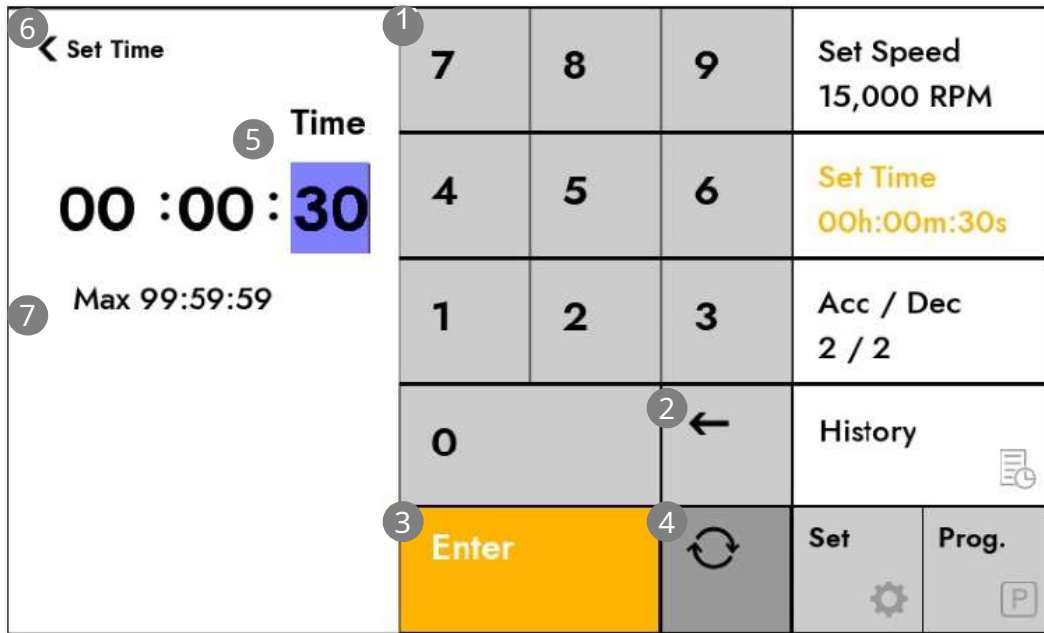

No.	Composition	Description
1	numeric keypad	- The setting value is changed when the numeric keypad is touched.
2	<- button	- When touched, the last input digit is erased.
3	ENTER	- Touch to complete input mode.
4	O button	- Cancels the entered settings and restores the previous settings.
5	Set value display	- Displays the set time value. - When entering time setting, the input cursor is displayed at the setting value in seconds. - Touch the area you want to change to display the cursor.
6	Back button	- When touched, it moves to the main screen.
7	Max Time	- Displays the input maximum time.

• Settable time: can be set up to 99:59:59

• If you enter more than 59 when entering minutes and seconds, it is changed to 59.

4.6 Acceleration/deceleration step setting

The acceleration/deceleration stage can be set to 3 acceleration stages and 4 deceleration stages.

- Press 'ACC/DEC' The setting screen appears on the left side of the screen.

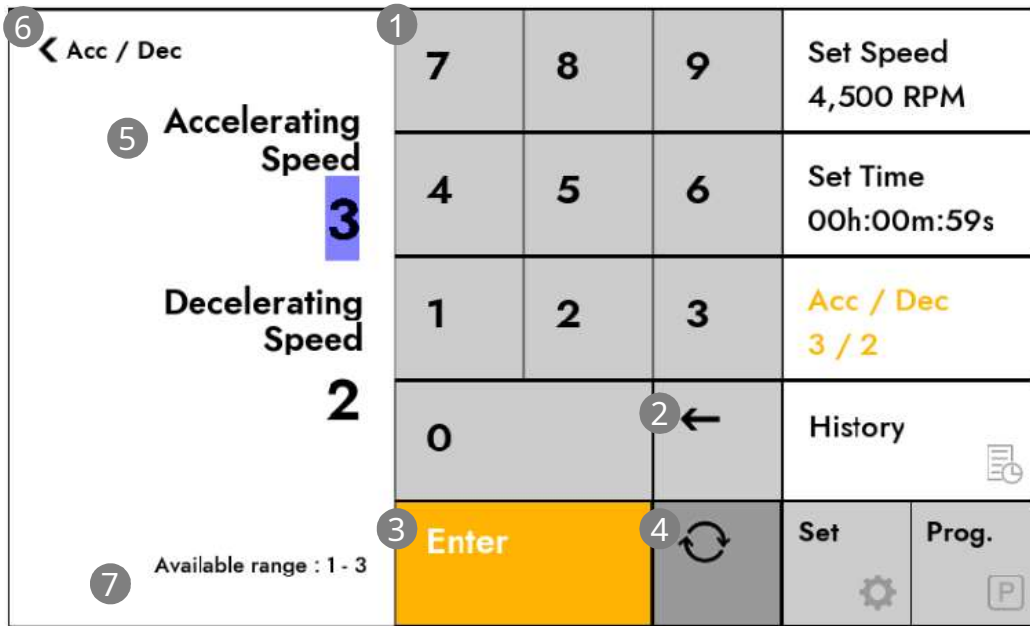

No.	Composition	Description
1	numeric keypad	- When the numeric keypad is touched, the setting value is changed.
2	<- button	- When touched, the last input digit is erased.
3	ENTER	- Touch to complete input mode.
4	O button	- Cancels the entered settings and restores the previous settings.
5	Set value display	- Displays the set Acc/Dec value. - A cursor is displayed for input of setting value.
6	Back button	- When touched, it moves to the main screen.
7	Input range	- Displays the input range. - It is automatically changed

- ACC setting range: 1 ~ 3
- DEC setting range: 0 ~ 3

4.7 History screen

You can check the operated value. Press the History button in the center right of the screen.

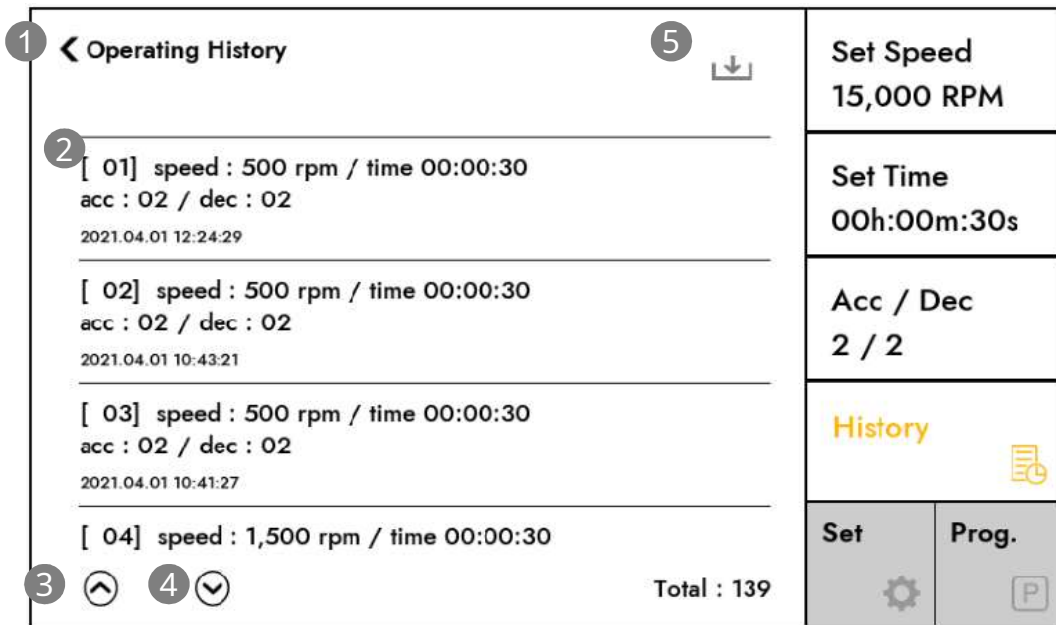

No.	composition	Description
1	Back button	- When touched, it moves to the main screen.
2	History List	- Shows the centrifuge operation history.
3	Page Down	- Scroll down the list by one page. - Press and hold to quickly scroll down the page.
4	Page Up	- Put the list up one page. - Press and hold to speed up the page.
5	Export	- Button to copy History Data to USB storage device - If the USB storage device is not connected or there is no data to be copied, it will be deactivated.

- History can be saved up to 1,000.

(After saving 1,000 pieces, the oldest data is deleted and saved.)

- If there is no history data, the list is not displayed and the phrase “No contents saved” is displayed.

4.8 Saving History

This is the screen to save the saved history to USB.

The USB port is on the LCD side of the Control Box (see p.20), and after inserting the USB ② Press to proceed as follows.

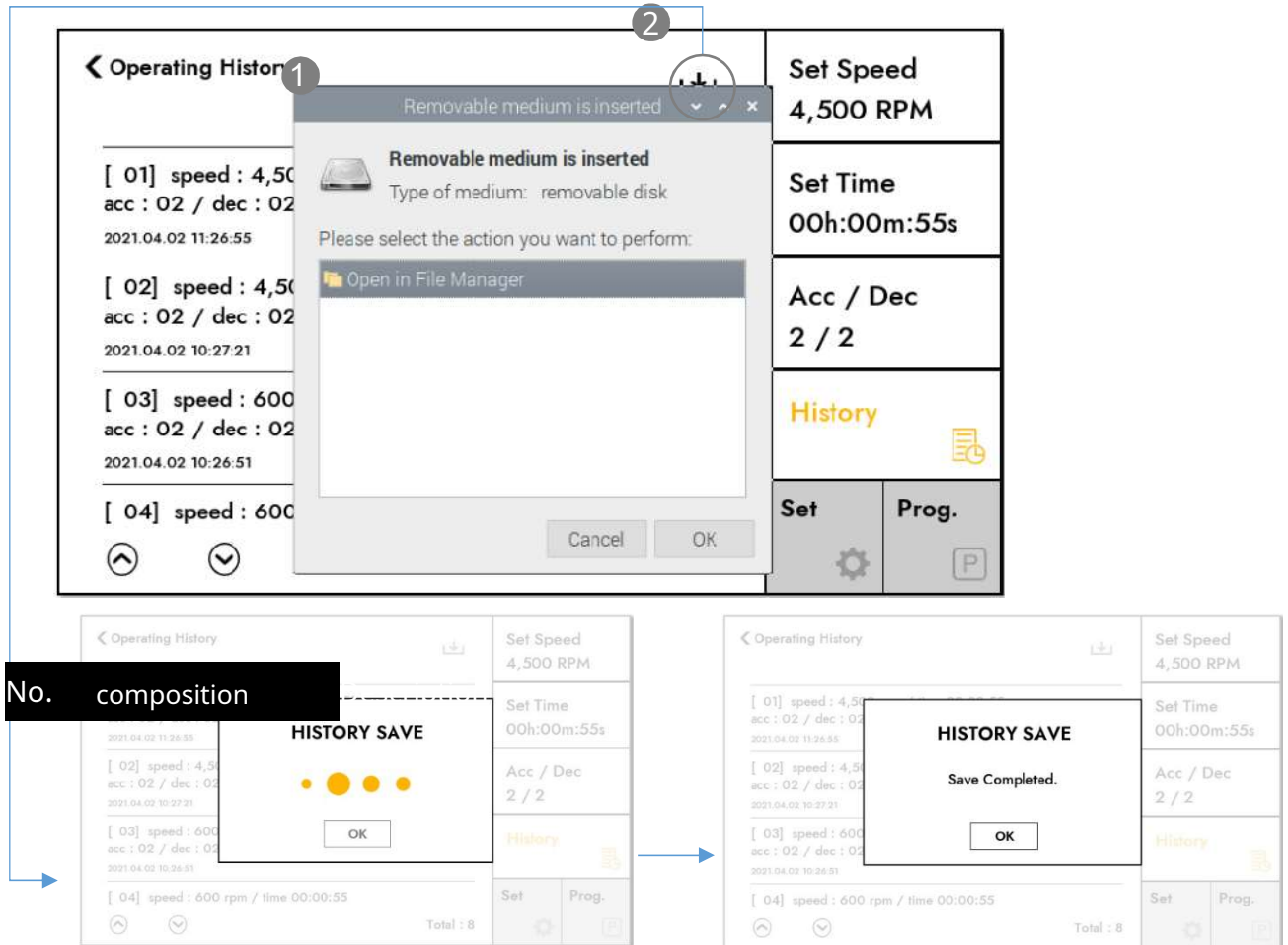

Click the [SAVE] button to start copying History Data to USB.

When copying is complete, the [OK] button is activated.

No.	composition	Description
1	USB connection pop-up	Popup that appears when connecting via USB (Pop-up generated by Raspberry pi system, cancel it.)
2	SAVE	If USB is connected and there is History Data to be saved, the button is activated.

- When History Data copy to USB is completed, USB is automatically unmounted and the SAVE button is disabled.
- Up to 1,000 usage histories can be stored, so it is recommended to periodically move the records to another medium.

4.9 Saving, Recalling and Deleting Programs

When operating the device under various conditions, after saving the set values such as speed and time in advance,

You can call it and use it right away.

Program save and recall are available from 1 to 99.

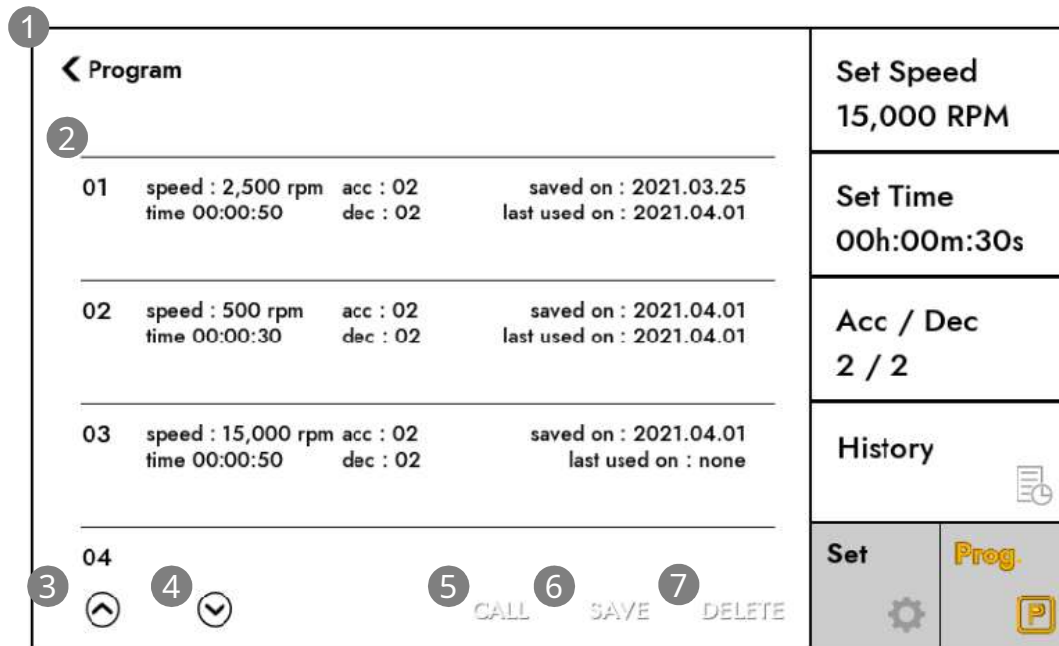

No.	composition	Description
1	Back button	- When touched, it moves to the main screen.
2	Program List (99 total)	- Shows the centrifuge operation history. - Saves the set value and displays the saved time (saved on) and the last called time (last used on).
3	Page Down	- Scroll down the list by one page. - Press and hold to quickly scroll down the page.
4	Page Up	- Upload the list by one page. - Press and hold to speed up the page.
5	CALL	- Load the saved Program.
6	SAVE	- The current setting value is saved in the selected Index.
7	DELETE	- Delete the selected Program.

[CALL / SAVE / DELETE button]

- CALL: Activated when a stored program is selected, and deactivated when an unsaved program index is selected.
- SAVE : Activated when List is selected.
- Delete: Activated when a saved program is selected, and deactivated when an unsaved program index is selected.

1 [Select unsaved program]

- CALL / DELETE button: Disabled.
- SAVE button: active.

2 [Select a saved program]

- CALL / SAVE / DELETE button: Activate all

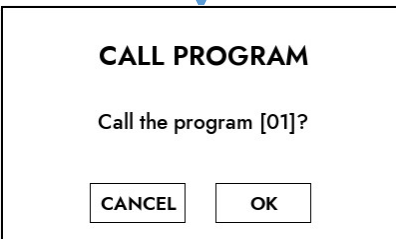
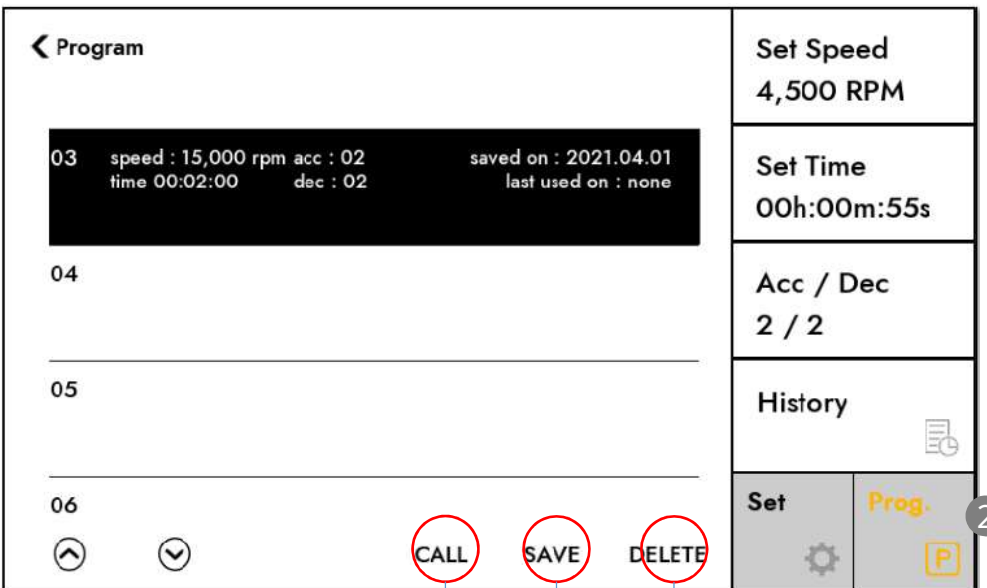

[CANCEL]: Return to the previous screen [OK]: Load the saved program and apply the settings to the main screen

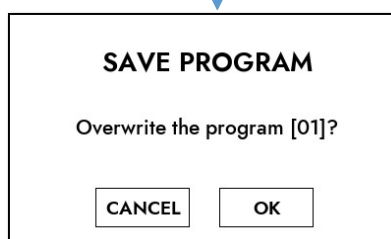

[CANCEL]: Return to the previous screen [OK]: Save the current setting value in the selected program

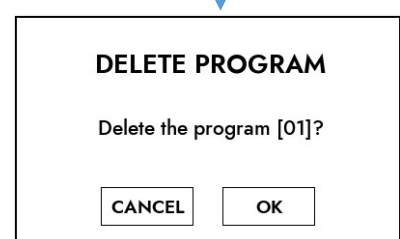

[CANCEL]: Return to the previous screen [OK]: Delete the selected program

4.10 Start/Stop

It can be used to start or stop motion.

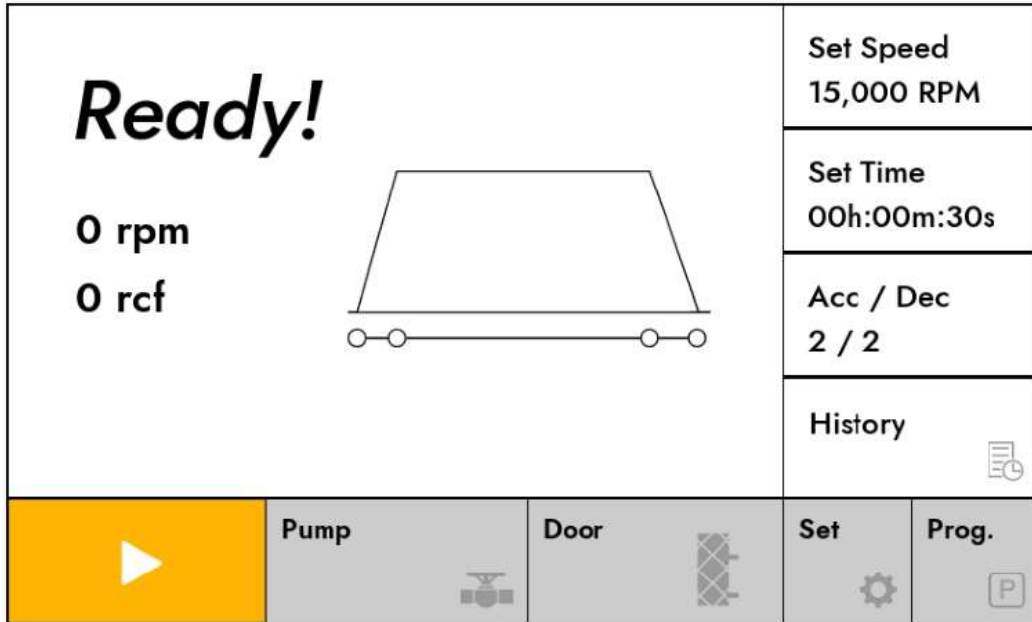

[Standby - Status Screen]

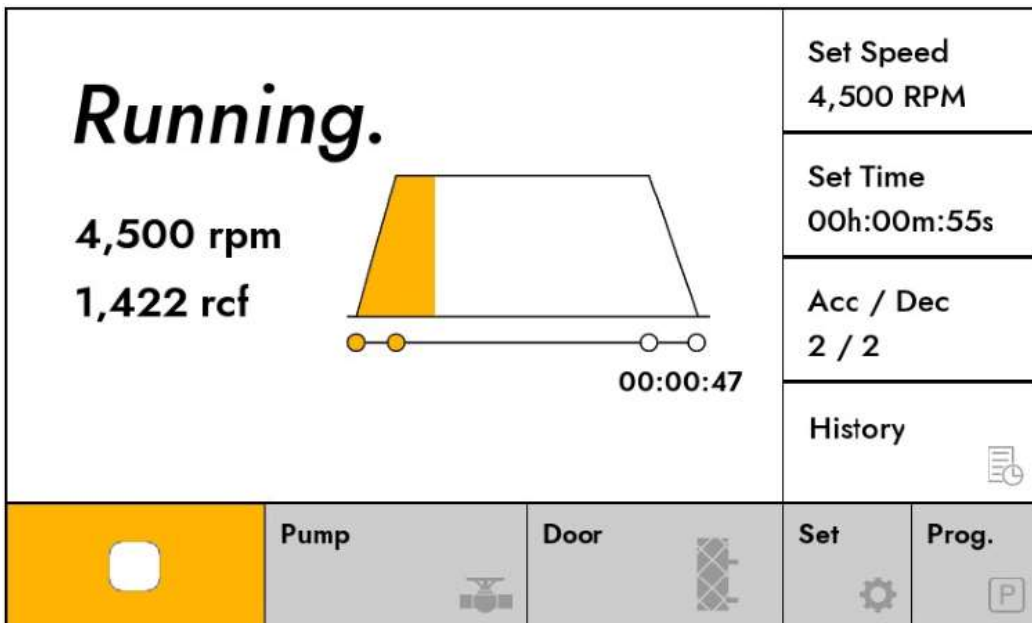

[In operation - Status screen]

4.11 Emergency stop

If you press the emergency stop button located on the front of the control unit to respond to an abnormality during operation of the product, it operates as follows. It stops in natural deceleration mode with a warning message.

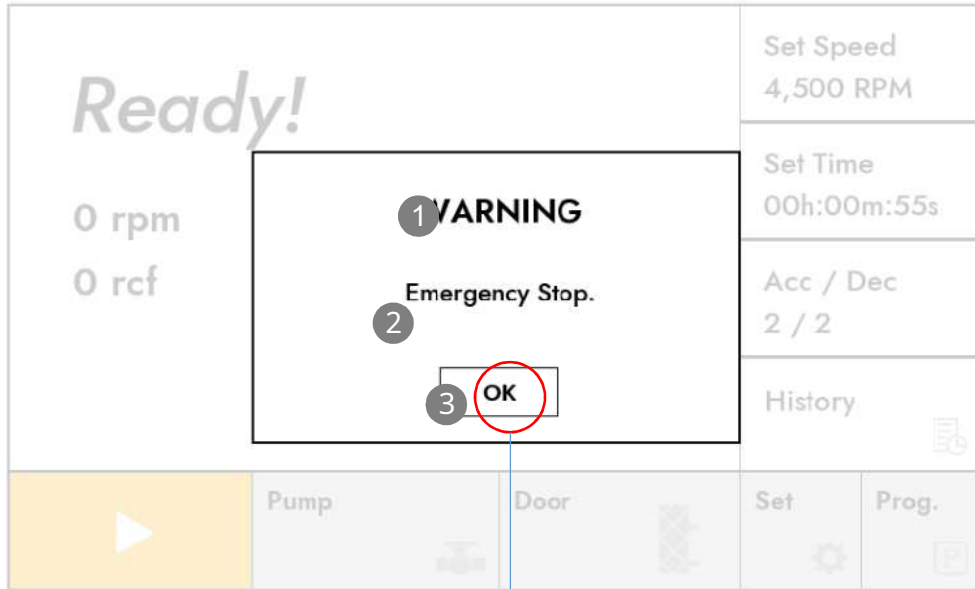

No.	Composition	Description
1	Title	- Title of Message Box is displayed.
2	Message	- The contents of the Message Box are displayed.
3	ok	- When the ok button is touched, the Message Box disappears.

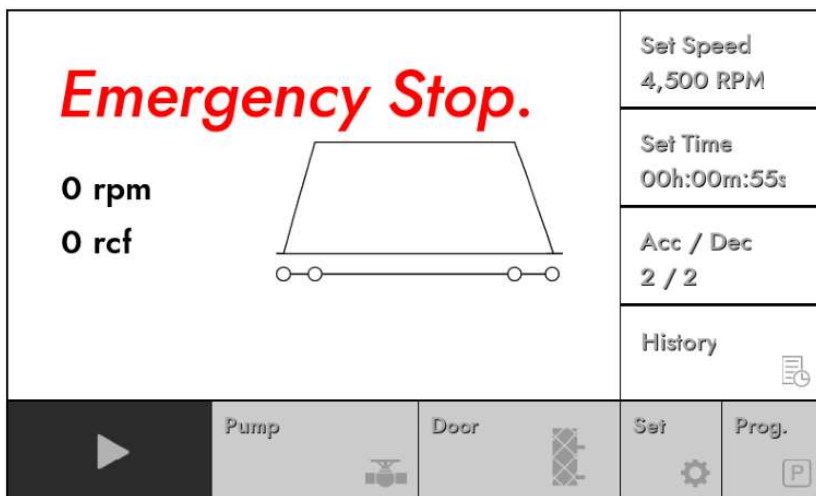

- In case of emergency stop, the message box is displayed and when the message box disappears, the phrase "Emergency Stop" is displayed at the top of Main and blinks every 500ms.
- When Emergency Stop occurs, all buttons are disabled.

4.12 Pump Operation

Pump operation operates in both Program Mode and Manual Mode. In the internal program, the pump operates from the time the set rpm is reached as shown in the figure below.

It is designed to stop when deceleration starts, but the pump can be turned on/off manually during operation.

Running

4,500 rpm

1,422 rcf

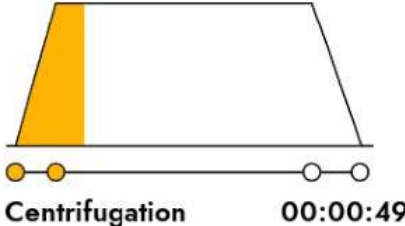



Set Speed
4,500 RPM

Set Time
00h:00m:55s

Acc / Dec
2 / 2

History



Pump
1

Door

Set

Prog.

No.	Composition	Description
1	PUMP	PUMP action Image

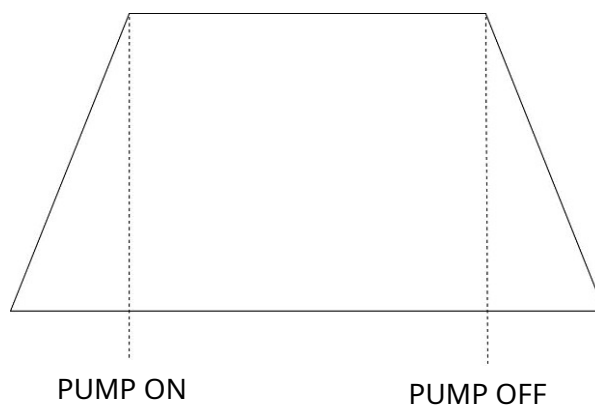

- When the set RPM is reached, the PUMP turns ON (RUN) automatically.
- In the section where deceleration starts, PUMP is automatically OFF (STOP).
- When the set RPM is reached, you can turn on/off the PUMP by touching the PUMP button.
- PUMP cannot be turned on/off in the acceleration/deceleration section.

4.13 Operation completion status display

This is the operation completion status display screen.



No.	Composition	Description
1	Title	The Title of the Message Box is displayed.
2	Message	The contents of the Message Box are displayed.
3	OK	When the OK button is touched, the Message Box disappears.

4.14 Setting screen

This is the screen where you can set items.

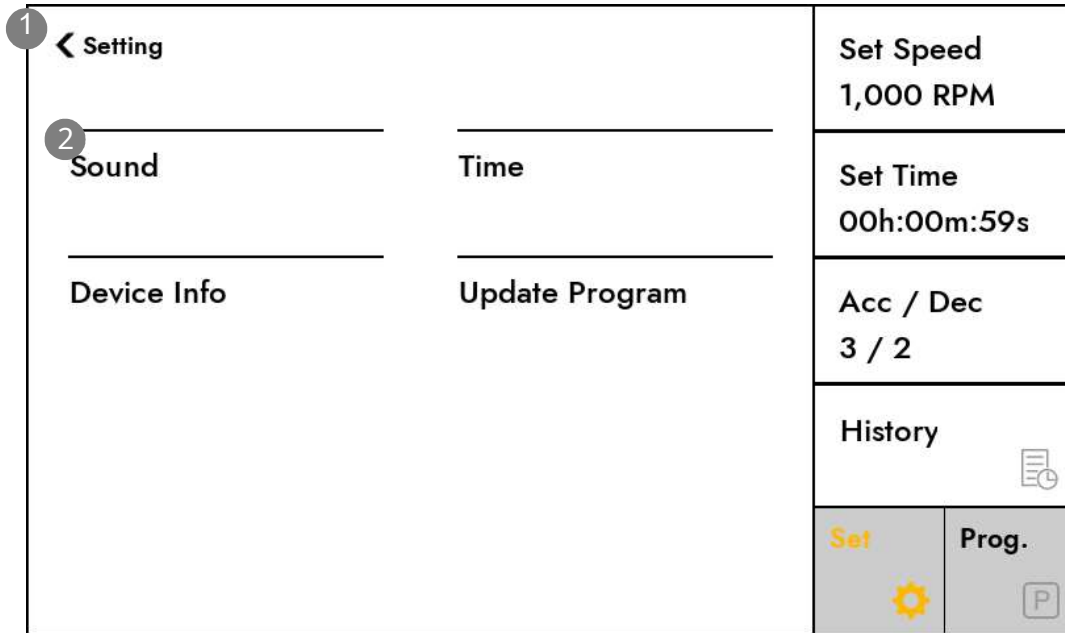

No.	Composition	Description
1	Back button	When touched, it moves to the Main screen.
2	Menu	Enter the selected menu.

4.14.1 Changing Sound Settings

Sound Enable/Disable, you can set the pitch.

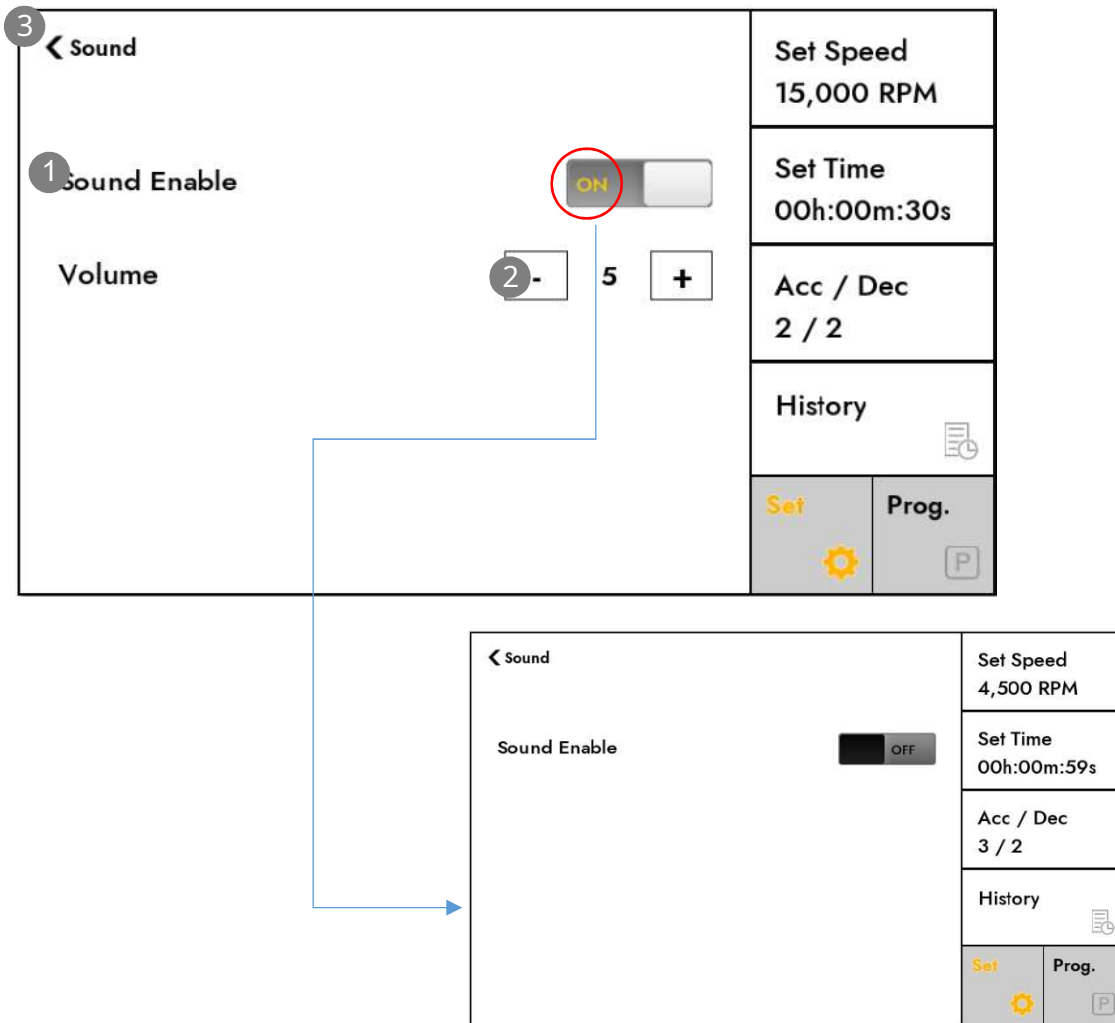

When set to Sound Off, the Volume menu disappears.

No.	Composition	Description
1	Sound Enable	- Displays Sound On/Off. - When the Switch button is clicked, it is changed to Off.
2	Volume	- Each time the "-" / "+" button is touched, the volume is changed.
3	Back button	- When touched, it moves to the Setting screen.

• Volume setting

You can set a value between 0 and 10.

When the volume is changed, the sound is played with the applied volume.

4.14.2 Time setting change

You can set the country, year, date and time.

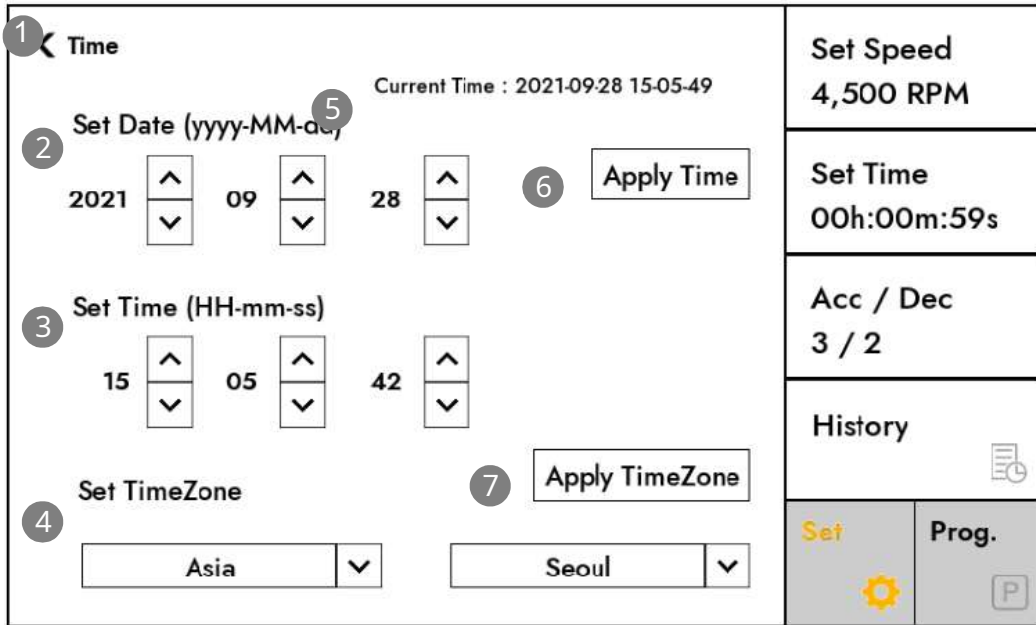

No.	Composition	Description
1	Back button	- When touched, it moves to the Setting screen.
2	Set Date	- Set the date.
3	Set Time	- Set the time.
4	Set Time Zone	- Set Time Zone. - The first list sets the continent, the second list sets the city. - When you touch each item, a message box with a list that can be set is displayed.
5	Current Time	- Displays the current system time.
6	Apply Time Apply	- Apply the set time to the system.
7	Time Zone	- The set time zone is applied to the system.

• UP/DOWN

[Date] In the case of February, if the date cannot be set, it is automatically changed to the last date of February.

(Example: If March 30, 2021 is set and you change to February, it is automatically changed to 28.)

Months: 1 to 12 are rotated.

Day: 1 to the maximum set date (rotates up to the maximum set date according to the month)

[Time]

Hour: Rotate 0 ~ 23.

Minutes: Rotate from 0 to 59.

Seconds: Rotates 0 to 59.

4.14.3 Device Information screen

You can check the product name, program version, number of operation cycles and accumulated RPM values.

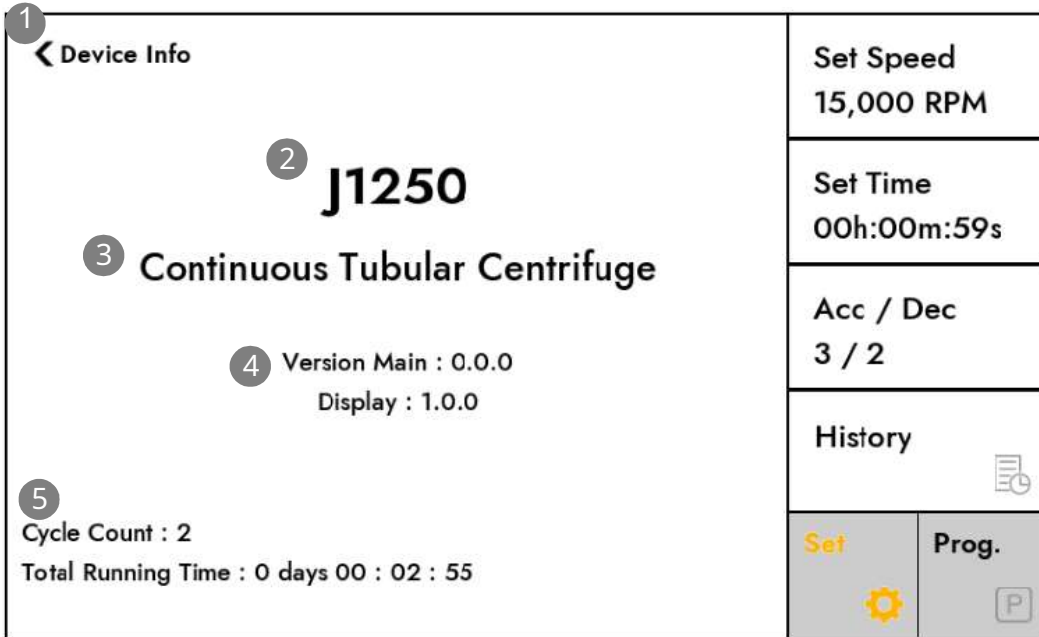

No.	Composition	Description
One	Back button	When touched, it moves to the Setting screen.
2	Model Name	Displays the Model Name.
3	Summary	Displays the description of the Model.
4	Version	Displays the version. (Main / Display)
5	Cycle / Running Time	Displays centrifuge operation information.

[Cycle Count]

- Displays Count for centrifuge operation.
- Cycle Count is +1 after 1 second after reaching the set RPM.

[Total Running Time]

- Displays the total running time of the centrifuge.

4.14.4 Display Program Automatic Update Screen

After saving the program update file in the USB, it is automatically recognized when inserted and the program can proceed.

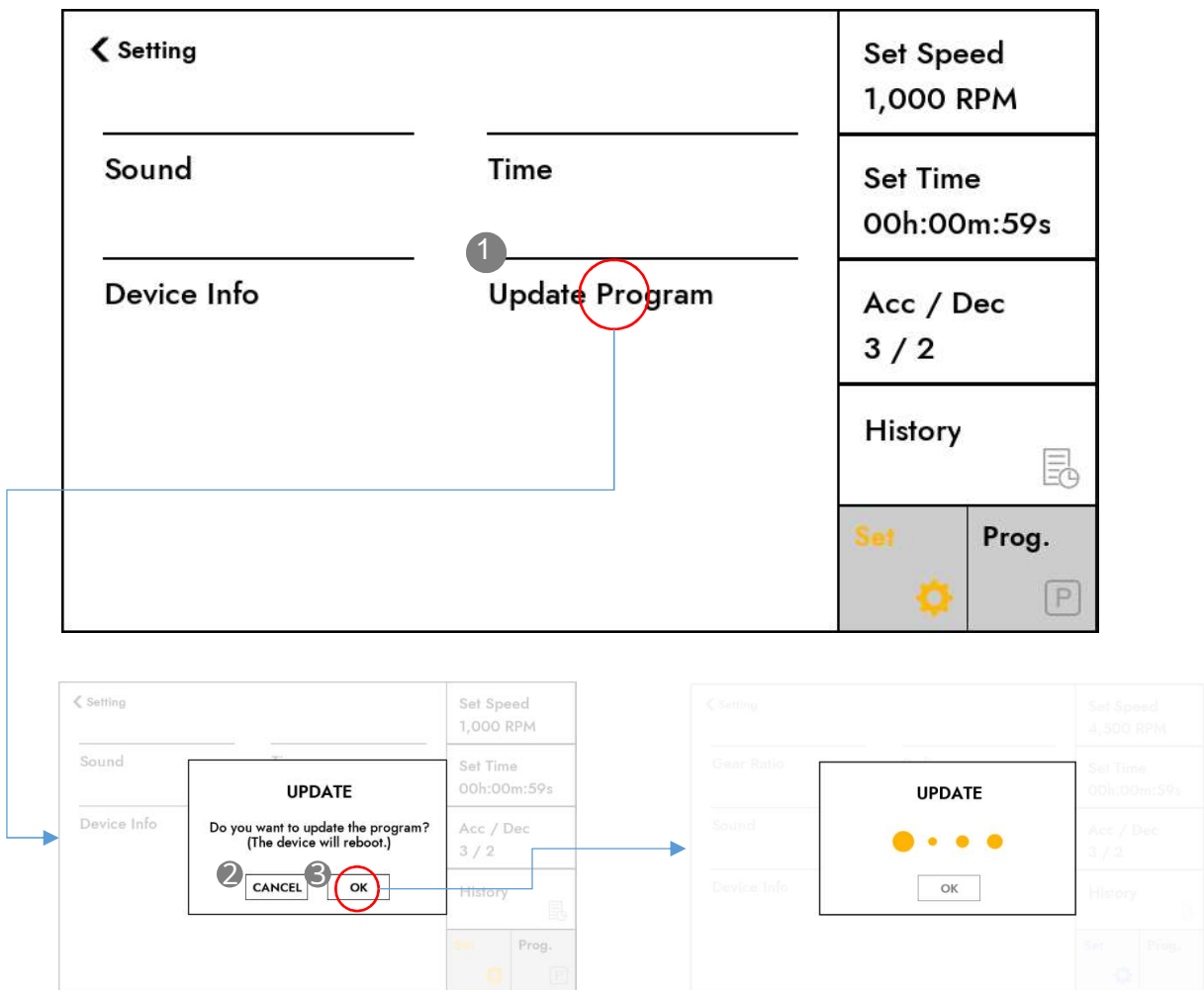

No.	Composition	Description
1	Update Program	- When the Update Program is confirmed, it is activated. - If the update program is not confirmed, it will be deactivated.
2	CANCEL button	- Close the UPDATE Message Box.
3	OK button	- Proceed with the UPDATE procedure.

• Update Program

1. Update is performed through USB.
2. The program should be saved in the root/Update Centrifuge UI folder on the USB.
3. The [Update Program] button is activated only when the USB is connected and the root/Update Centrifuge UI folder is checked.

4.15 Display of error occurrence status during operation

This is the screen that appears when an error occurs.

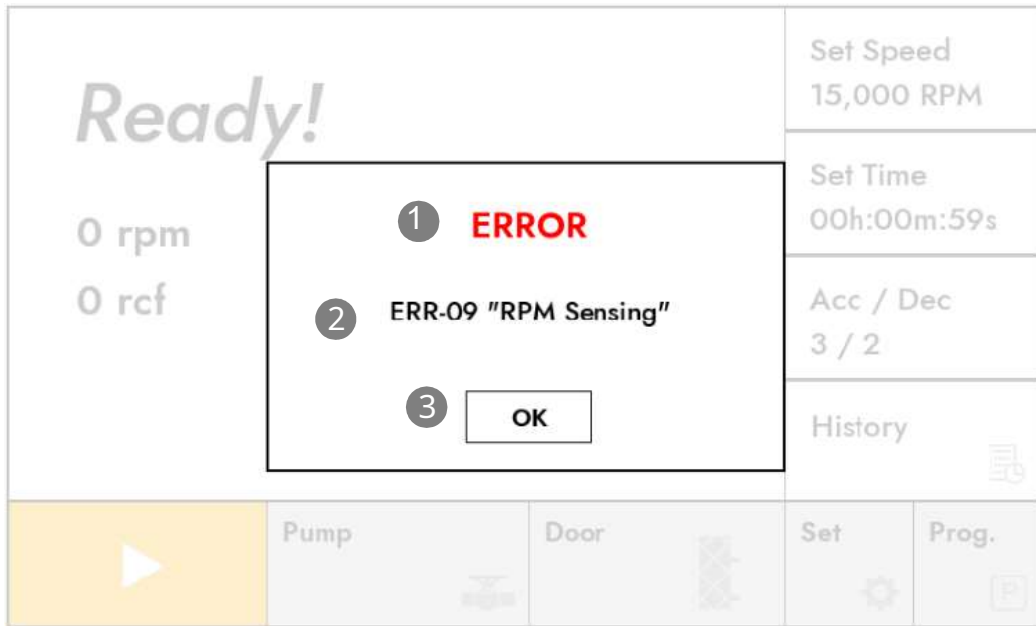

No.	Composition	Description
1	Title	- Title of Message Box is displayed. (In case of Error Message Box, the title color is displayed in red.) - When a pop-up is displayed, a notification sound is also played
2	Message	- Error contents of Message Box are displayed. (Predefined Error Code and contents are displayed.)
3	OK	- When the OK button is touched, the Message Box disappears.

- The Error Message Box appears on any screen.

[Error Message Box]

- When an error occurs in the centrifuge, an Error Message Box is displayed.
- Error occurs again even if the Message Box disappears by touching the "OK" key of the Message Box while the action is not completed.
- Even if the error action is completed, the Error Message Box does not disappear and disappears only when the "OK" key is touched.

5. Preparing and How to Drive

5.1 Bowl assembly

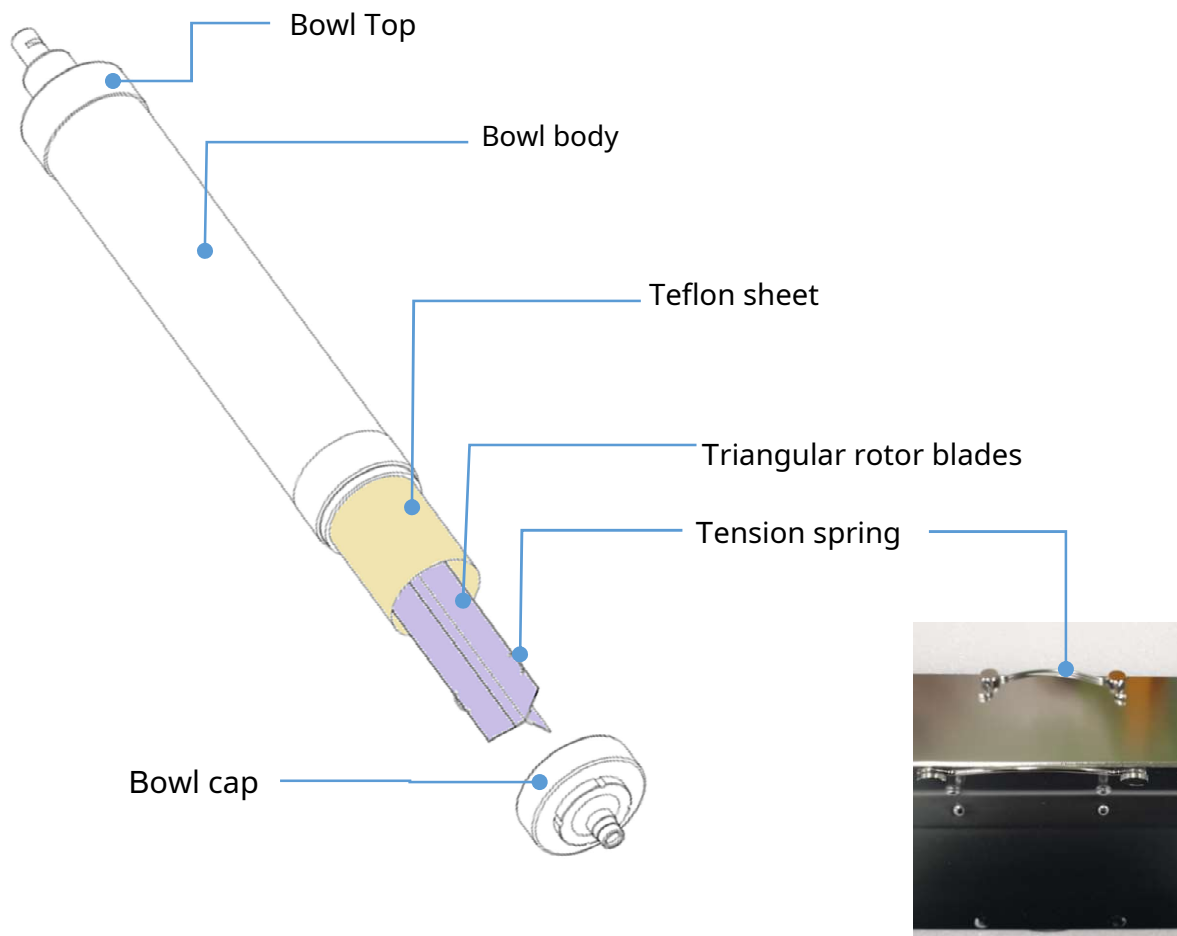

5.1.1 Insert Teflon Sheet

For harvesting of centrifuged solid samples, the inner bowl must be covered with Teflon sheet. Teflon sheet is manufactured and supplied according to the inner diameter of the bowl, so you can use it as it is. Insert so that the front side is the sample contact area.

- ① Place the bowl on the trolley, fold the Teflon sheet and slide it into the bowl.



- ② Adhere the Teflon sheet to the bowl and fix it.

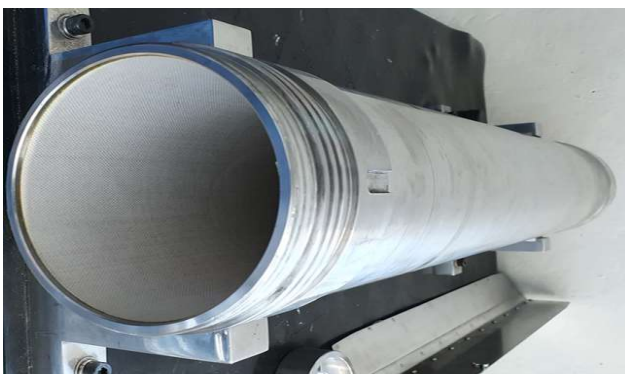

5.1.2 Inserting the triangular rotor blade

- ① Insert the triangular rotor blade with the same serial number as the bowl body so that the tension spring is positioned in front (Bowl cap).

Tension spring



- ② Insert carefully so that the tip of the wing does not touch the interlocking part of the Teflon sheet.

Teflon sheet

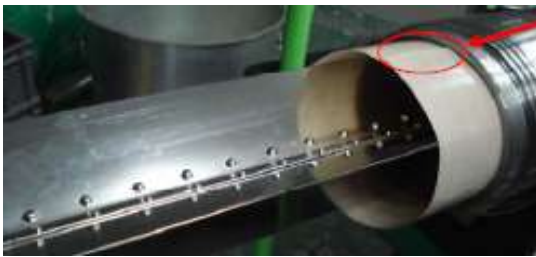

- ③ Hold the upper end of the bowl and insert it all the way.

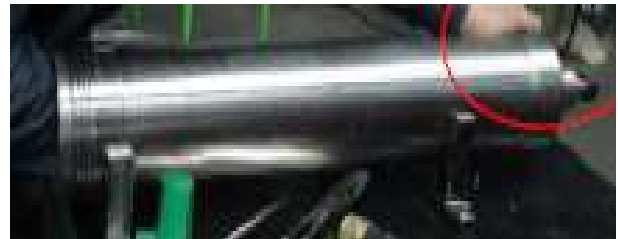

- ④ Prepare a bowl cap with the same serial no as the bowl body.

Bowl cap



⑤ Before assembling the bowl cap

Visually check the insertion and fixation of the bowl cap sealing gasket (loose or dripping) and whether there is any foreign matter, and then tighten the bowl cap by hand to match the thread.

If the bowl cap sealing gasket is worn out or out of position, it may cause leakage during operation. When removing the bowl cap, check that the bowl cap sealing gasket is fixed as previously inserted.



⑥ After tightening the bowl wrench to match the center of the bowl, fully tighten it using a Urethane hammer.



⑦ If the bowl cap sealing gasket is damaged, replace the sealing gasket after loosening the bowl cap, wiping and removing foreign substances.



Bowl cap sealing gasket

⑧ Bowl cap nut is worn or worn out, replace it.



Bowl Cap nut

5.2 Drag body assembly mounting

① Mount the Drag body assembly using Urethane hammer.



Drag body assembly



Drag bushing

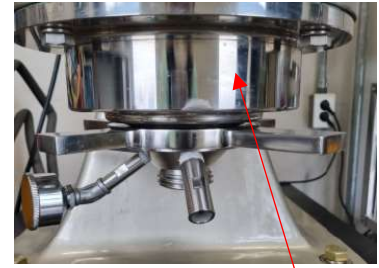

Drag Frange

② After inserting the inlet nozzle into the center hole of the drag body assembly from the bottom up, assemble it by fastening the drag hand nut. The inlet nozzle is installed with 3Ø by default, and it is replaced after testing with Ø4 or Ø5 inlet nozzles depending on the solid size of the sample or the amount of injection.



Inlet nozzle



5.3 Bowl installation

① Insert the bowl cap nut into the inner diameter groove of the drag bushing.

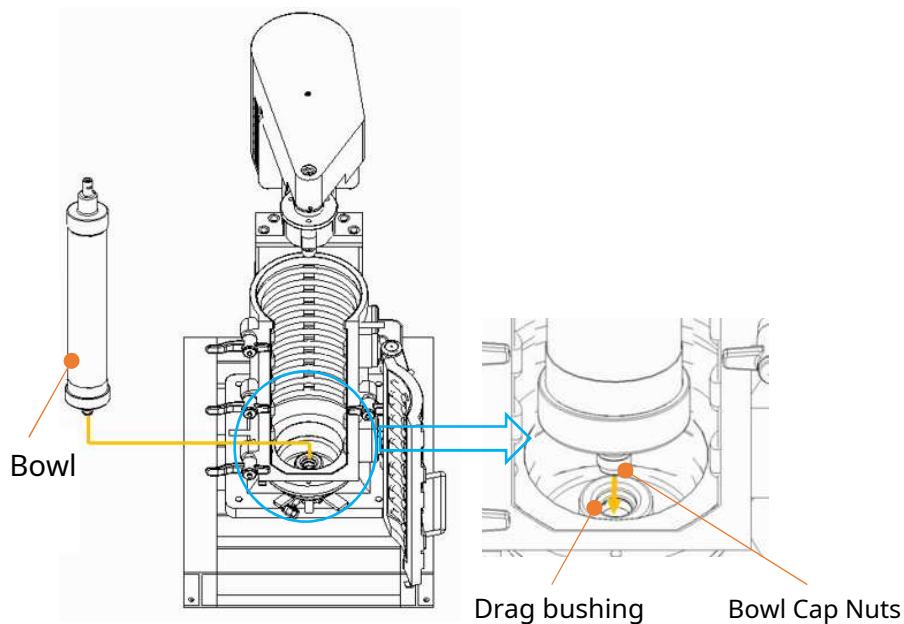

② Insert the Supernatant Outlet according to the inner diameter groove of the bowl.

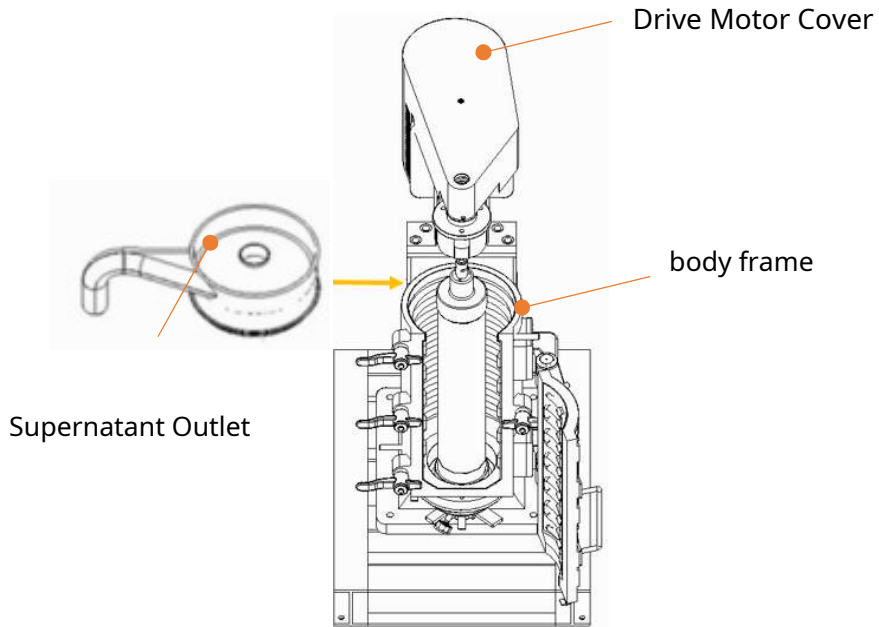

③ Insert the Supernatant Outlet lid into the Supernatant Outlet inner diameter groove.

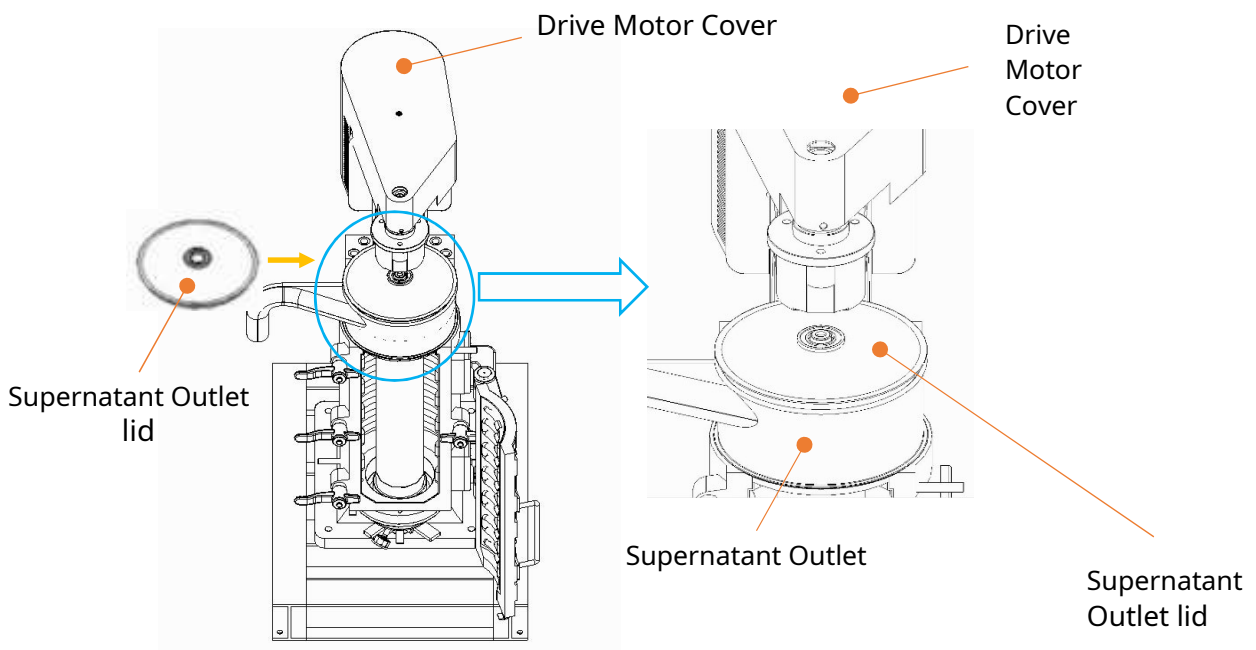

5.4 Bowl and Motor Spindle fastening

- ① Lower the spindle inserted in the pulley flange and insert the lower part of the spindle into the inner diameter groove of the upper bowl to connect the spindle and bowl. (It is fastened with the bowl and rotates)

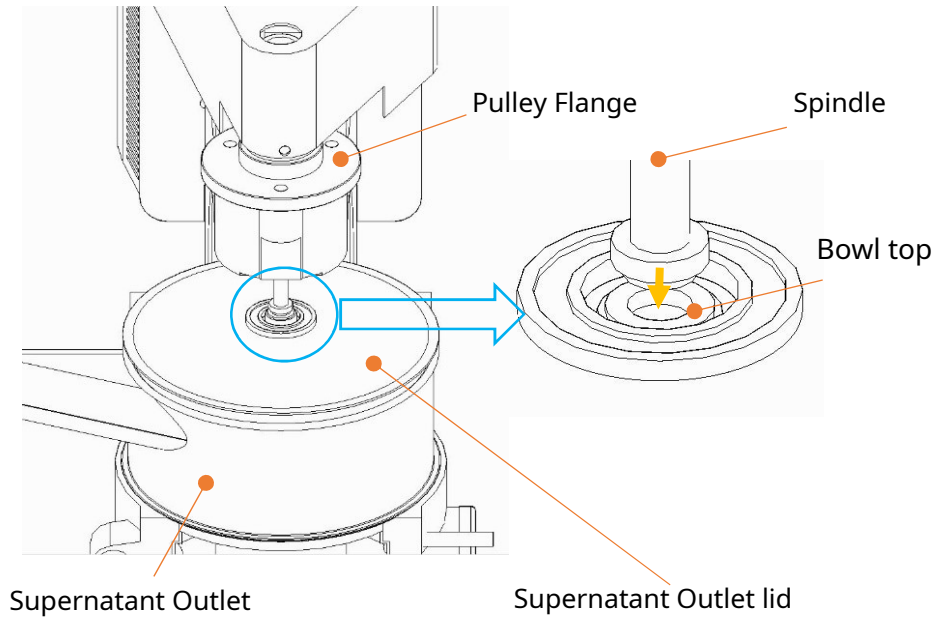

- ② Fasten the seated spindle and the top of the bowl in a clockwise direction with the coupling nut inserted in the pulley flange.

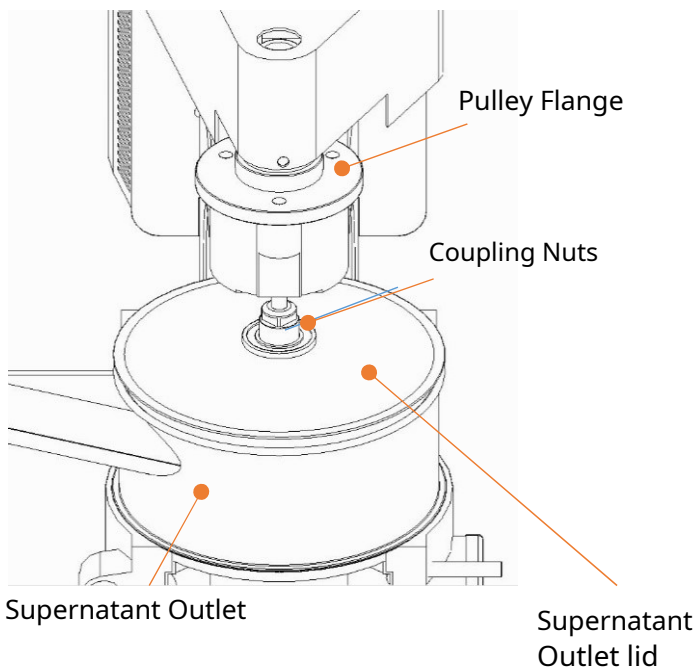

③ After tightening the coupling nut,

Turn the spindle protective sleeve screwed inside the pulley flange counterclockwise to fix the Supernatant Outlet lid so that it does not move.

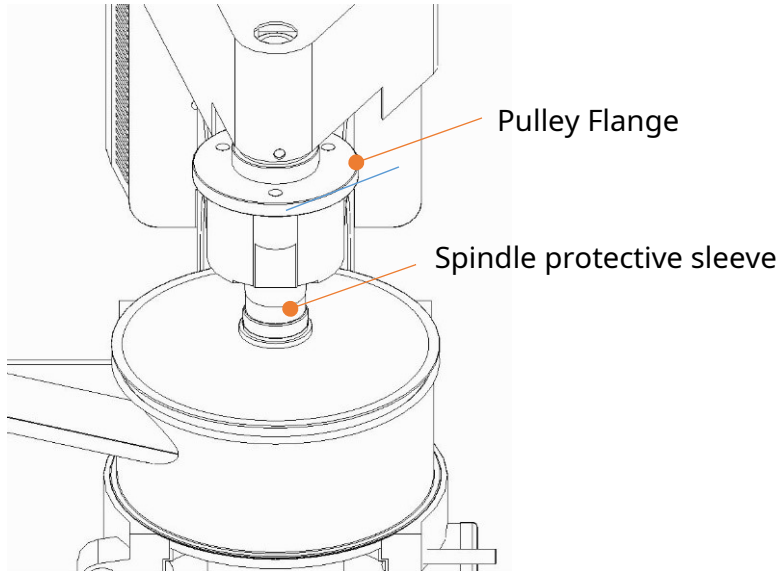

5.5 Things to check before driving

- Mount the Drag body assembly using Urethane hammer (refer to p48)
- Carefully insert the bowl into the drag bushing hole in the frame. (see p48)
- Install the Supernatant Outlet and Supernatant Outlet lid. (see p49)
- Close the main body door. After applying maximum tension to the door lock handle device by hand, tap it 2-3 times with a Urethane hammer to finish.
- Lower the spindle (refer to page 50)
- After confirming that the lower part of the spindle and the upper groove of the bowl are aligned, fasten the coupling nut and bowl using a coupling wrench and urethane hammer. (see p50)
- Pull down the spindle protective sleeve and tighten it as much as possible. (see p51)
- Connect the Sample-in tube to the sample inlet and connect it to the sample bottle through the pump head of the sample feeding pump.
- Connect the supplied outlet hose to the supernatant outlet on the top of the device to collect the centrifugation supernatant. (See p13 & p53)
- Turn the grease cup halfway and put grease in to lubricate the bowl rotation.

- It is recommended to rotate the grease cover 1/4 turn every 60 minutes during operation.



Grease cup: Lubricating grease injection device when bowl rotates



Grease

- ⑪ Check No. 1 to No. 8 again and balancing with reference to p21~p22 once again to check the state of the device and, if it is correctly joined, operate the motor.

5.6 Driving

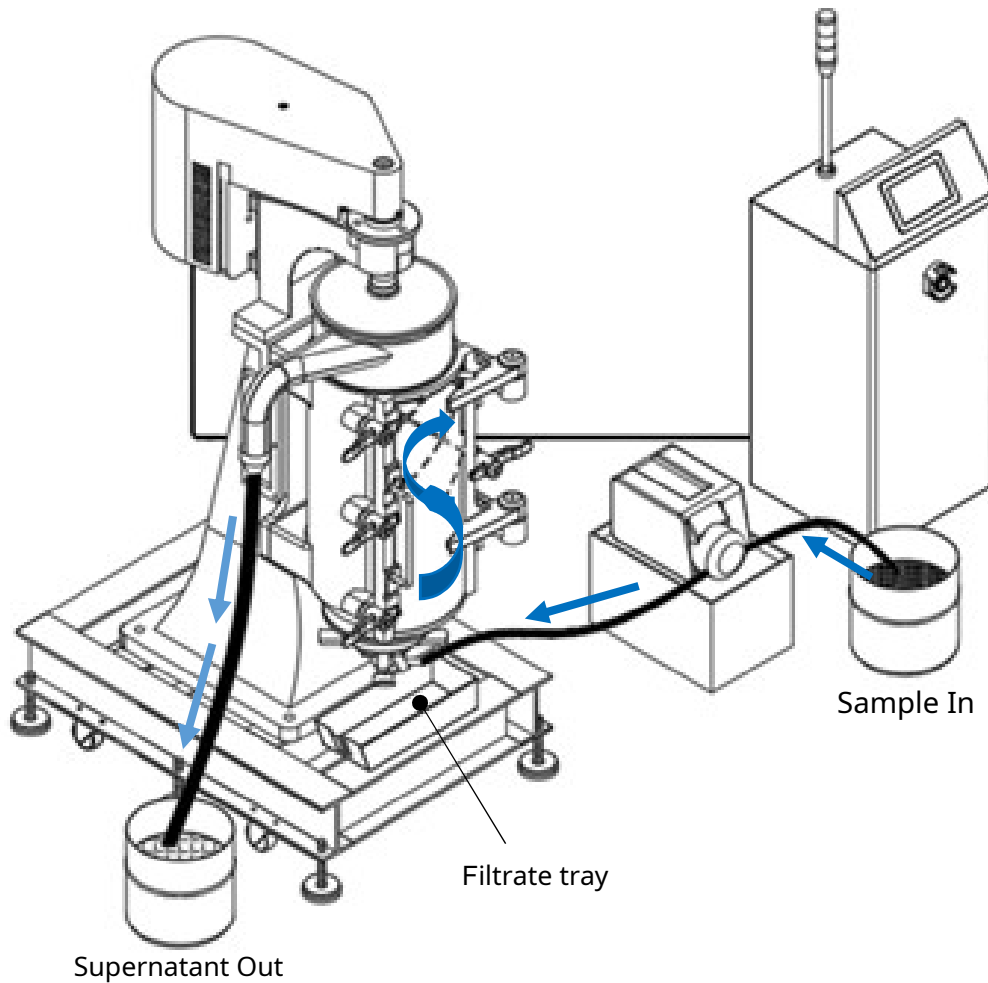

- There may be some shaking at the beginning of the start, but it is stabilized as the rotation becomes faster. If there is noise (clicking sound) or vibration, stop driving immediately and find out the cause of the noise.
- When the set rotation speed is reached and there is no abnormality, the metering pump automatically injects the sample and starts the sample separation operation.
- Stop is automatically stopped when the set time has elapsed.
(However, it is not allowed to stop while the sample is being fed, so the motor must be stopped after stopping the sample feeding. Also, make sure that the motor is stopped after confirming that all the upper liquid has been discharged and no longer comes out)
- If operation is stopped after work is finished, the liquid remaining in the bowl loses centrifugal force and flows out from the drain pipe of the lower drag to the filtrate receiver.

6. Disassembly and maintenance

6.1 Disassembly

6.1.1 Bowl disassembly

- Check the bowl stop status.
- Remove the spindle cover. (Attached to the top of the body)
- Open the Door.
- Separate the coupling nut and bowl under the spindle using coupling and urethane hammer.
- Remove the Supernatant Outlet & lid.
- Remove the bowl and place it in the trolley groove.
- Remove the bowl cap.
(Put the bowl vice on the bottom of the bowl seal and separate it with a bowl wrench)
- For the triangular rotor blade, attach it to the hole at the bottom and safely separate it.
- Remove the Teflon sheet inside the bowl by pulling it down slowly using your hands.
- Collect the sludge using Setular.

6.1.2 Drag body assembly disassembly

- Drag body assembly After removing the nozzle fixing nut, separate the nozzle.
- Remove the grease pipe. (Use a monkey wrench, turn counterclockwise)
- Turn the drag handle counterclockwise using a urethane hammer.
- Hold the lower part of the drag body and turn it counterclockwise, and then separate it from the lower part of the body.

6.2 Cleaning

- Use a high-pressure nozzle (water) and a bowl cleaner to clean the inside. (Use neutral detergent)
- After placing the bowl cap and body on the trolley, dry them naturally or dry them with a soft, dry cloth before storage. The areas where the bowl cap and body connection are lead-free blazing are frequently washed with water and neutral detergent. (Caution: If the bowl is immersed in acid or basic material for sterilization, the thin film of the blazing coating may peel off or melt, so it is absolutely prohibited)
- If solids remain in the bowl, it may cause vibration. Be sure to clean it every time the operation is stopped.
- Check the condition of the sealing gasket of the bowl cap and remove the material.
- Remove foreign substances from all parts in the drag body assembly.

6.3 Daily Inspection

- ① Check whether the drag bushing has more than 1.5mm of wear or deformation compared to the normal bushing.
 - Check if the amount of grease is sufficient. (Replenish and use when insufficient)
 - Check the wear condition of the cap nut at the bottom of the bowl.
 - After assembling the bowl, rotate it by hand to check whether it rotates smoothly.
 - After simply fastening the bowl and the motor spindle, rotate them by hand to check the eccentricity.

6.4 Maintenance

6.4.1 If the belt is damaged

- ① If damage or scratches are seen on the contact surface between the drive motor and the pulley cap, smooth it with fine sandpaper.
- ② When the belt is driven from the top or bottom, adjust the tension pulley arm up and down so that the belt can rotate to the correct position.

6.4.2 In case of bowl abnormal vibration

- Be sure to thoroughly clean the bowl every time the operation is stopped so that no solids remain in the bowl.
- Always use the provided tool to clean the surface of the spindle connection part (coupling nut) of the bowl after tightening it.
[Caution] Even minor damage may affect the bowl balance, so please check it regularly.
- If the damage to the spindle is visually confirmed, if there is a scratch or foreign material on the contact point with the top of the bowl, clean it and keep it clean.
- If there is a phenomenon that the triangular rotary blade mounted on the bowl flows down or there is an inclination in the bowl, please adjust the elasticity of the tension spring at the bottom of the triangular rotary blade.
- If the surface of the bowl cap nut is damaged, replace it.
- If the upper part of the bowl is bent or the bowl cap cannot be fastened, stop using it and contact the manufacturer.
- ⑦ In the case of other, unexplained, bad vibrations, please contact the manufacturer.

6.4.3 If the bowl cap sealing gasket is damaged

- During operation, a leak occurs in the bowl cap due to rotational force, resulting in leakage of the injected sample. Please replace it immediately.
 - If a large scratch or separation phenomenon is found on the contact surface, please replace it immediately.
- [Caution] When replacing, always check whether the bowl cap is positioned correctly.

6.4.4 Rubber coupling is damaged

- ① After checking that the rubber coupling is in close contact with the inside of the pulley cap, replace it immediately if it is cracked or damaged.
 - : Remove and replace cracked or damaged rubber coupling inside the pulley cap.

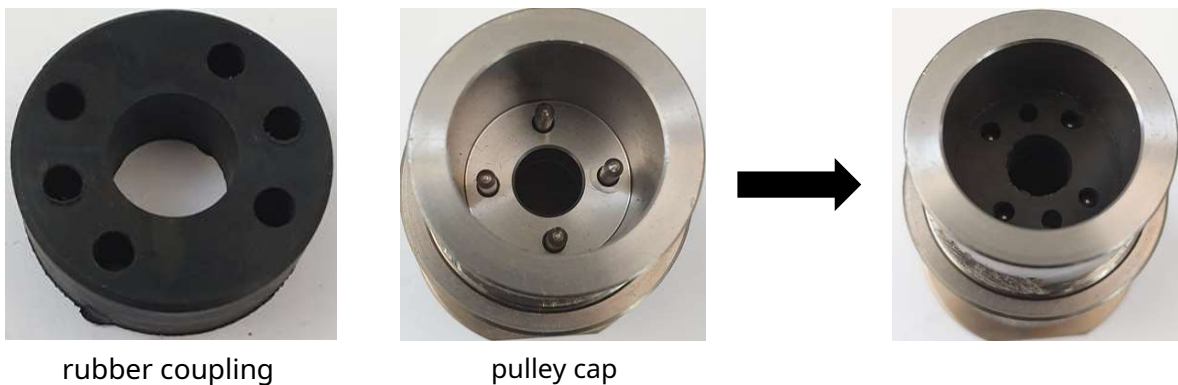
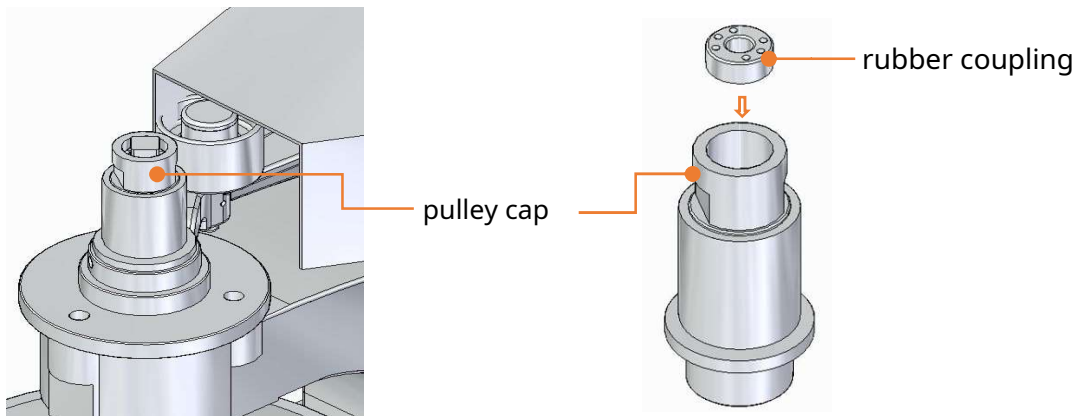

- ② Visually check the female & male clutch and replace it immediately if damage is confirmed.

6.4.5 If the drag bushing is damaged

- ① When checking with the naked eye, if the inner diameter is large, please replace it.
- ② If the degree of wear is biased to one side, please check the device balance before replacement.

6.5 Bad Code Description

ERR -0 Serial communication error

Check the status of the internal connection cable for data transmission/reception error between Main and Display.

ERR -1 motor start error

It is caused by delay of initial motor operation time or not rotating. Check the communication status between the motor cable and the inverter.

ERR -2 Door open error during operation

An error occurred due to the door being opened during operation. Check the door closed status and sensor.

ERR -3 Motor overheat error

An error occurs due to heat generated by the motor during operation.

Remove any heat generating devices around the equipment, and check the motor fan operation.

ERR -7 Control unit error

This is a system error in the control unit. After replacing the control unit, check again.

ERR -9 RPM Sensing error

It occurs because the motor rotation speed is not fed back. Check the status of the inverter communication cable connection.

ERR -15 Motor temperature sensor error

It occurs because the motor temperature sensor is not recognized. Check the connection status of the motor temperature sensor.

ERR -42 Set value range exceeded error

Occurs when the set value exceeds or falls below the standard. Check the settings again.

ERR -43 Inverter error

It occurs when there is no communication or no connection between Main and the inverter. Check the cables & inverter

7. Ordering Information

Cat. No.	Description	Remark
J1250	J1250 Continuous centrifuge, Main unit	
J1250SS	J1250 Continuous centrifuge, Main unit , Stainless Steel	
J1250SSWJ	J1250 Continuous centrifuge, Main unit , Stainless Steel with Water Jacket for J1250	
BW9-TS	BOWL(Stainless Steel) with a Trolley (Stainless Steel) and Teflon sheet (3ea)	
J-CTS-380-7	Controller unit with 7" LCD and Inverter for 380V, Stainless Steel, Stand-alone	
J-TF	Teflon sheet for J-1250 (395 X 733mm)	
P-WT600	Peristaltic Tube Pump incl. a Pump Stand (WT600-2J)	

MEMO

hanil

Hanil Scientific | HANIL Scientific Inc.

16, Arayuk-ro, Gochon-eup, Gimpo-si, Gyeonggi-do

ihanil.com

© 2022 Hanil Scientific Inc. All rights reserved.